



Industrial
Pumps



fluimac[®]
pump solution





Fluimac was established in 2012 Varese area in Italy. This young, dynamic and innovative company is specialized in providing pump solutions using their newly developed designs of pump product ranges.

With their large knowledge, experience and expertise, in the Italian and International markets, Fluimac is well equipped to offer not only reliable, high quality products but also a staff infrastructure providing its customers with the benefits of total flexibility, coupled with fast service, speedy deliveries and a superb after sales service.

The Fluimac policy is based on excellent customer service and a network of efficient and knowledgeable distributors who ensure the customer to receive the best possible attention at all times. The company is continually researching new solutions and is dedicated to the constant improvement of their product ranges. Highly trained personnel provide our customers with the guarantees of quality, efficiency and a high degree of technical ability and support.

Our experience, serving to **you!**

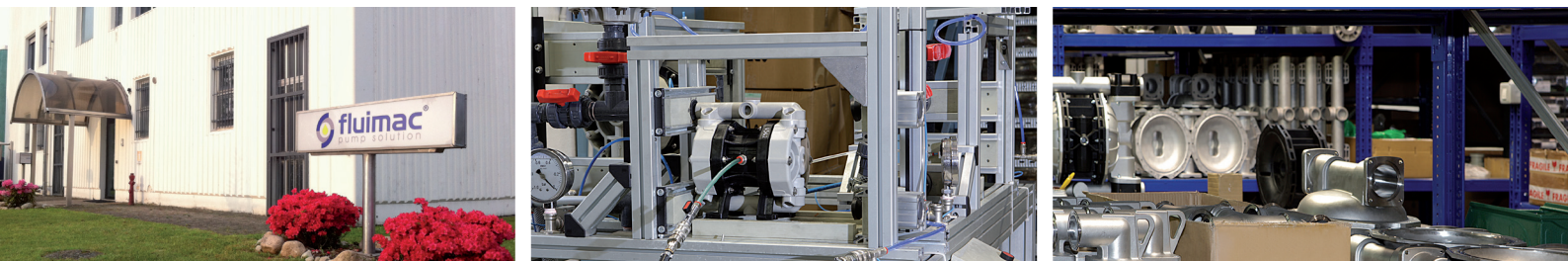

Fluimac's subsidiary in **Singapore**



Our Singapore branch was established to strengthen our presence in the fast growing Asian market. Our office takes care of the sales and aftersales, and strongly supports the extensive network of distributors we have in the region. With ready stock in Asia, we have fast delivery capabilities to the region.



The grouping and organisation of Fluimac, assembly, pump testing and warehousing facilities, along with the rapid stock check process system in place, allows the company to offer an outstanding, fast delivery service for those customers who find themselves in an emergency situation.

We are proud of our, high technology, automated test facility which allows us to test each and every pump hydrostatically as well as for suction condition, discharge pressure and flow rate tests.

Our technical and R&D departments are engaged constantly in finding practical and high technological solutions to ensure continuous improvement to our product ranges. The result is that the Italian genius and excellence of Fluimac keeps the company in the forefront and cutting edge of modern day pump innovation.

Our quality, serving to **you!**



Fluimac's Certificates

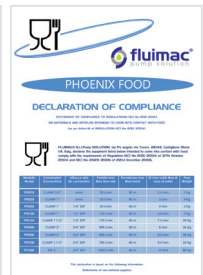
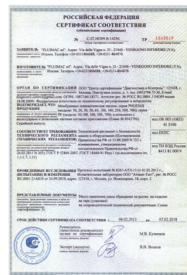

CE CONFORMITY MARKING



ATEX



ISO 9001:2008



GOST-R RUSSIA



FDA COMPLIANT



EC 1935/2004 CONFORMITY



EAC CONFORMITY MARKING

Products

Air operated double diaphragm pumps have long been recognized as the most flexible pumps of the industry for handling difficult liquids at relatively low pressures and flows. The range of applications is virtually limitless. Fluimac AODD pumps come in many sizes and choices of materials of construction. Almost every type of liquid from highly corrosive acids through high viscosity paints and adhesives, to food and drink products can be pumped.



Phoenix



Air operated double diaphragm pumps Realized in:
 PP, PVDF, ALUMINIUM, SS AISI 316, POMc
 Flow-rate from 8 lt/min to 1.000 lt/min
 Connection from ¼" to 3".



Phoenix Food



Air operated double diaphragms pumps
 Realized in:
 SS AISI 316 electro-polished and PP food grade (P7)
 Flow-rate from 8lt/min to 1.000 lt/min
 Tri-Clamp Connection.



Phoenix Atex



Air operated double diaphragms pumps, ATEX certified for zone 1. Realized in:
 PP+CF, PVDF+CF, ALUMINIUM,
 SS AISI 316, POMc+CF
 Flow-rate from 8lt/min to 1.000 lt/min
 Connection from ¼" to 3".



Accurate Phoenix



Double diaphragm pumps with remote control
 Realized in:
 PP, PVDF, ALUMINIUM, SS AISI 316, POMc
 Flow-rate from 8 lt/min to 700 lt/min
 Connection from ¼" to 2".



Drum Phoenix



Air operated double diaphragms pumps with special Features to empty drums and tanks
 Realized in:
 PP, PVDF, ALUMINIUM, SS AISI 316, POMc
 Flow-rate from 8 lt/min to 160 lt/min
 Connection from ¼" to 1".



Twin Phoenix



Air operated double diaphragms pumps with special Features with double inlet/outlet
 Realized in:
 PP, PVDF, ALUMINIUM, SS AISI 316, POMc
 Flow-rate from 8 lt/min to 700 lt/min
 Connection from ¼" to 2".



Damper



Pneumatic, automatic pulsation dampeners. Realized in:
 PP, PVDF, ALUMINIUM, SS AISI 316, POMc
 Applicable to all size of pumps.
 Available also in ATEX or FOOD version.

Markets & Applications

Fluimac pumps are some of the most versatile pumps on the market. They can be used in a variety of installations in numerous applications



Features & Benefits

Variable flow and head pressures, easy to adjust, without sophisticated controls.	100% wet tested after final assembly: deadheading, priming, and sealing.	ATEX certifications in all versions: Conductive plastic pumps available.	Portable and compact for multi-location use, optionally with trolley.	All plastic air system: strong and corrosion-resistant in harsh environments.	Handled liquids with solids particles: ideal for abrasive and viscous media.
Special Air system: lube-free, non-stall, non-freeze.	Wide Range of sizes and materials suited to variety of conditions and chemicals fluids.	Dry-run without damaging the pump or system: seal-less design.	Self-priming dry up to 6 meters: works in suction lift applications.	Efficient performance: high flow rates through optimal casings designs.	Special air exhaust: Designed to operate at low noise levels.
Efficient air distribution design: low air consumption.	Safely "dead head" function, against closed discharge, without pump damage.	Fully submersible: can be submerged completely according to the fluid compatibility.	Can customize to specific applications: Multiple porting options available along with interface options.	All Bolted Construction: it provides maximum leak resistance and safety.	Serviceability: easily maintained and quickly without any special tools.

AODD vs. Others

PUMP TYPE	AODD	CENTRIFUGAL	LOBE	GEAR	SCREW	PERISTALTIC	PISTON
Variable Flow & Head Control	✓	✓	✓	✓	!	!	✓
Deadhead Safely	✓	✓	!	!	!	!	!
Dry-Running	✓	X	X	X	X	X	X
Dry Self-Priming	✓	X	X	✓	X	✓	!
No Mechanical Alignment	✓	X	X	X	X	X	X
No Electrical Installation	✓	X	X	X	X	X	X
Portability	✓	✓	!	!	!	✓	!
Submersible	✓	!	X	X	X	X	!
Sealless	✓	!	!	!	!	!	!
Cavitation Tolerance	✓	X	!	!	✓	!	!
Low Shear & Degradation	✓	X	✓	✓	!	!	!

✓ = Suitable ! = Limitations X = Not Recommended

Technical Features

Un-balanced pilot spool, precisely controls positioning of the main power spool to eliminate stalling and increase efficiency

Long-lasting diaphragm construction ensures a consistent performance and a longer operating life

All bolted design for an effective sealing to extended leak-proof service

Special exhaust chamber with double silencer to expand diffusion passages, reduce the icing and assure low noise level

Solid polypropylene air chambers and plastic air valve for maximum chemical resistance in highly corrosive environments

Special pinch clamping, design to minimize wear e increase life of the diaphragm, and provides a uniform seal to avoid leak

Acetalic shuttle ensures long valve life, auto-lubricated material

Pneumatic exchanger is easily externally accessible for a quick inspection

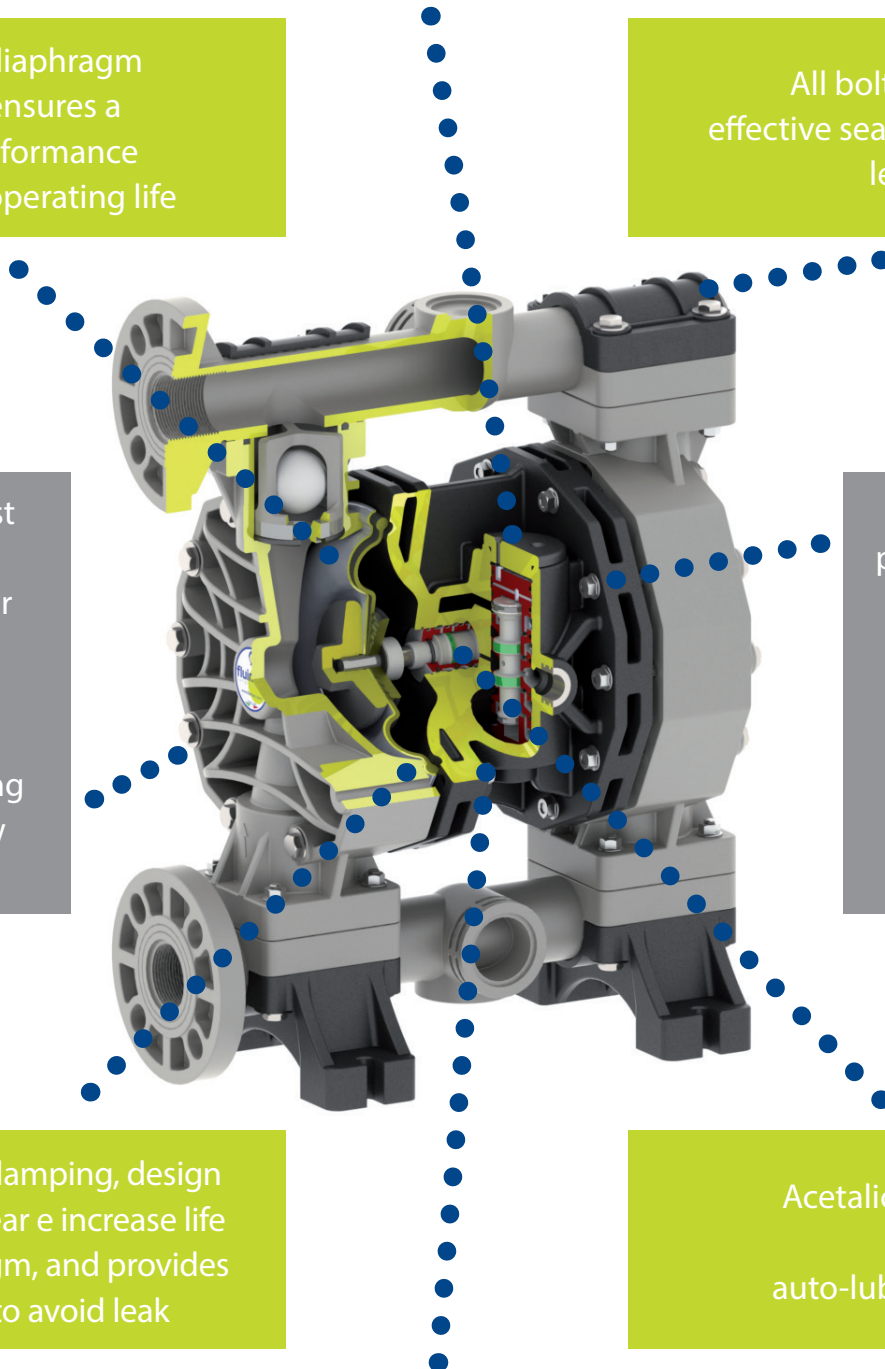

Pump Operation

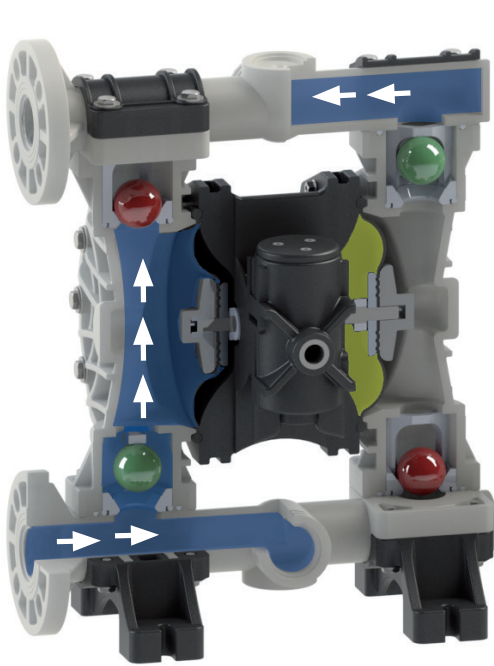

1. Suction Cycle

Compressed air fills right inner chamber, causing the opposing diaphragm to create suction, lifting the lower valve ball, pulling in fluid at inlet. Simultaneously, the right chamber is in "Discharge" cycle.

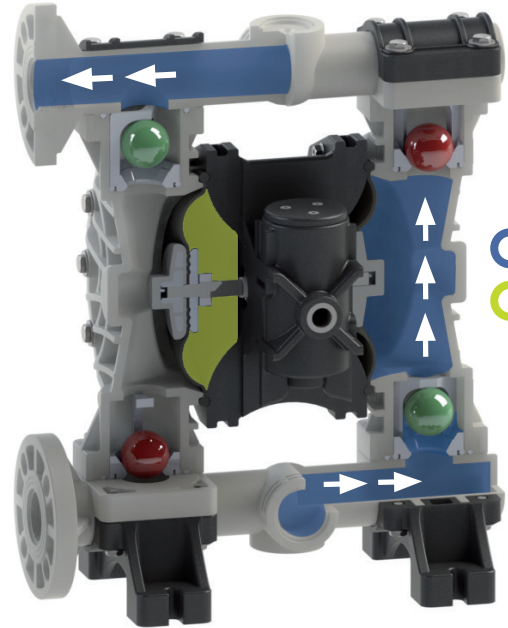

2. Discharge Cycle

Compressed air fills left inner chamber, causing upper valve ball to open and discharge fluid. Simultaneously, the right chamber is in "Suction" cycle.

○ Fluid
○ Air

Installation

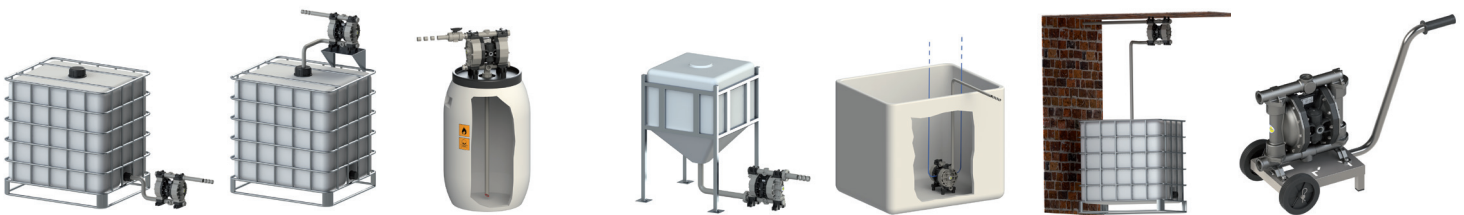

Pump installed below head (positive suction)

(when it is necessary to empty completely the container)

Self priming pump installed above head (negative suction)

(pump initially work with dry column without problem)

Pump installed above drum or tank

(with special featuring pump)

Pump installed on hopper for high viscosity liquid

(hopper's height helps the pump to treat the fluid. Air pressure has to be high, Suction tube has to be bigger than pump size)

Submerged pump

(it is necessary to check the chemical compatibility)

Suspended

special version with fixing feet also in the upper part, for ceiling fixing

Pump installed on a mobile unit

(with a trolley or cart when pump must be often moved)

How to read the code

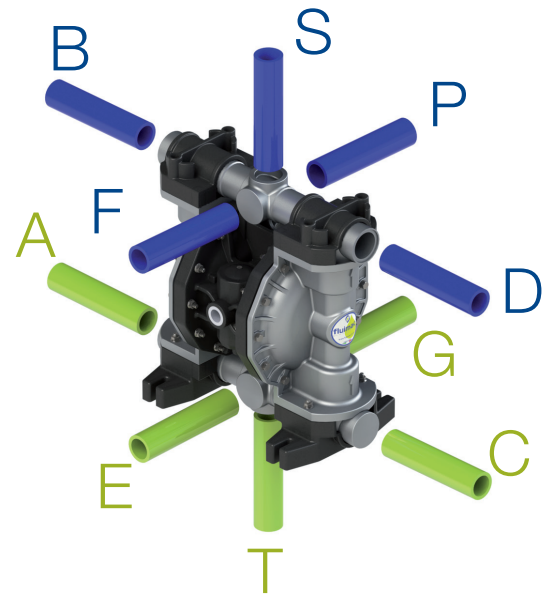
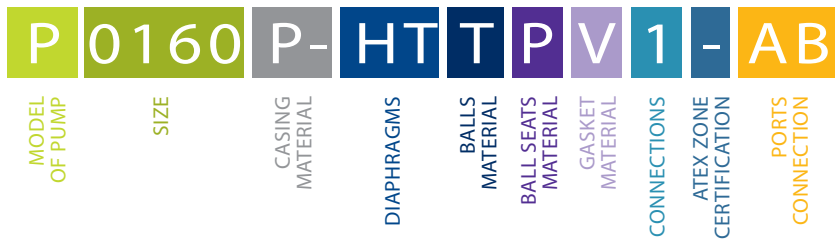

Pump selection

To select the right FLUIMAC pump for your application, the following factors should be considered to achieve economy of operation, long pump life, and minimal maintenance costs:

- The nature of the medium to be pumped, its viscosity, and the solids content
- Pumping capacity in relation to the desired output
- Suction and pressure conditions

Considering these parameters, an optimal pump size is selected when the intersection of the intended installation "pressure vs. flow rate" is near the middle section of the curves.

Using Performance Curves

To determine compressed air requirements and proper size for a FLUIMAC AODD pump, two elements of information are required:

- 1 Required Flow Rate
- 2 Total Delivery Head

As an example, consider a P160 pump performance curve, pumping about 135 l/min at 25m.

Point A on the performance curve is where the desired Flow Rate and Total Delivery Head points intersect. This point determines compressed air requirements for the particular pump.

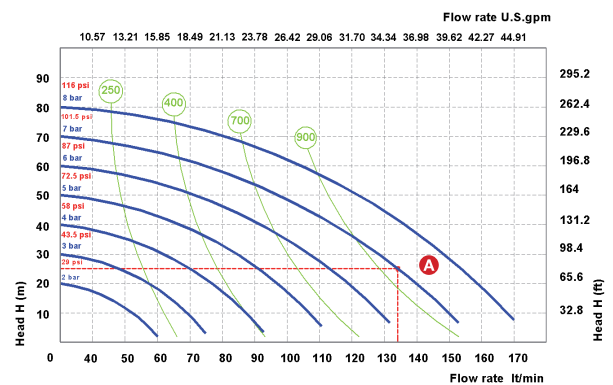

At performance point A, the pump will require approximately 7 bar air inlet pressure.

To arrive at this figure, follow the solid blue curve to the left to read the air pressure rating in BAR.

By looking at the nearest green curve, it is determined the pump will require approximately 900 nl/min (Normal Liter per minute) of air consumption.

Specified Suction Lift

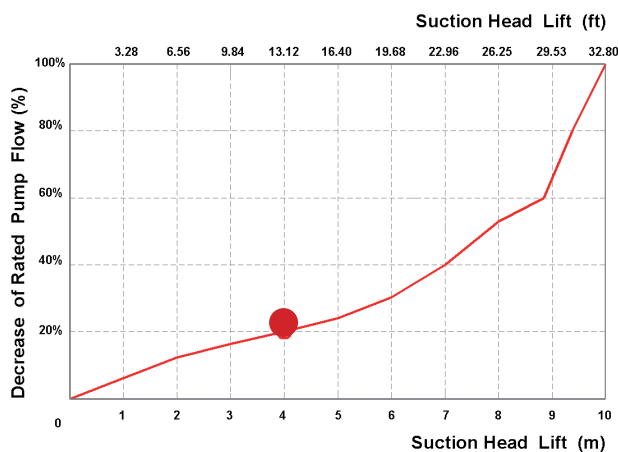

With a suction lift of 4 m, pump rate decreases by approximately 20%. Valid for pumps 3/4" and larger; data varies with pump configuration.

Viscous Liquids Performance Data

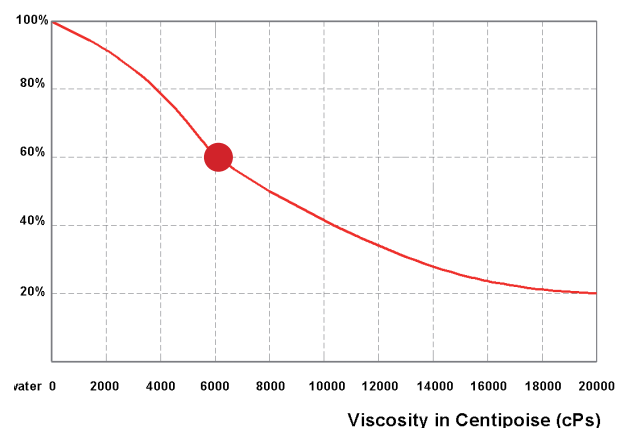

During the conveyance of a fluid with a viscosity of 6000cPs, the pump rate decreases to 60% of its rated value (100% = water). Valid for 3/4" pumps & larger.

Materials

PUMP CASING

Polypropylene



Polypropylene: Wide chemical compatibility. General purpose.

Polypropylene+CF



Conductive Polypropylene: Wide chemical compatibility. General purpose. Groundable.

PVDF+CF



Conductive PVDF: Strong chemical resistance to acids. High temperature resistance. Groundable.

POMc



Acetal: Wide range of solvent and hydrocarbons resistance. Good level of abrasion resistance.

POMc+CF



Conductive Acetal: Wide range of solvent and hydrocarbons. Good level of abrasion resistance. Groundable.

Aluminium



Aluminium: Wide range of solvent and hydrocarbons. Good level of abrasion resistance.

SS - AISI 316



Stainless Steel AISI 316: High level of corrosion and abrasion resistance.

SS - AISI 316 Electropolished



SS - AISI 316 Electropolished: High level of corrosion and abrasion resistance. Food Version.

Materials

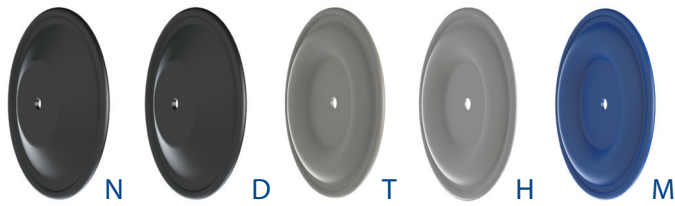

Diaphragm

NBR: Good for petroleum-based fluids, water, oils, hydrocarbons and MILD chemicals.

EPDM: OK with caustic solutions, dilute acids, ketones and alcohols. Good abrasion resistance.

PTFE: Widest chemical compatibility, extreme corrosion resistance, non-adhesive, high heat resistance.

HYTREL: Good low temperature properties. Good abrasion resistance.

SANTOPRENE: solutions and dilute acids.

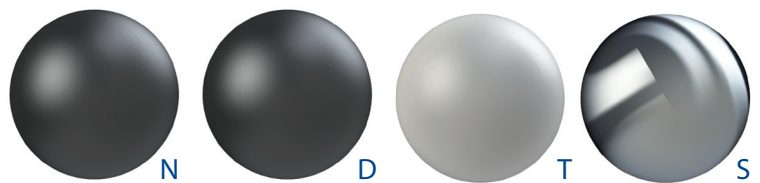

Ball Check

NBR: Good for petroleum-based fluids, water, oils, hydrocarbons and MILD chemicals.

EPDM: OK with caustic solutions, dilute acids, ketones and alcohols. Good abrasion resistance.

PTFE: Widest chemical compatibility, extreme corrosion resistance, non-adhesive, high heat resistance.

SS: High level of corrosion and abrasion resistance. Good for viscous fluids.

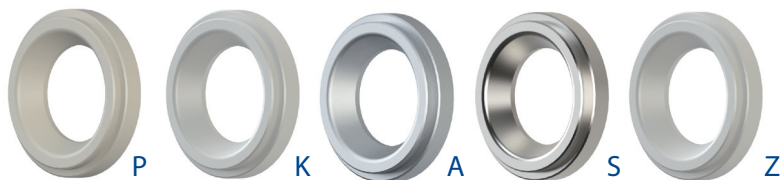

Seat

POLYPROPYLENE: Wide chemical compatibility. General purpose.

PVDF: Strong chemical resistance to acids. High temperature resistance.

ALUMINUM: Wide range of solvent and hydrocarbons. Good level of abrasion resistance.

SS: High level of corrosion and abrasion resistance.

PE: with high molecular weight: High level of abrasion resistance



Orings

VITON: High heat resistance. Good resistance to aggressive chemicals and hydrocarbons.

NBR: Good for petroleum-based fluids, water, oils, hydrocarbons and MILD chemicals

EPDM: OK with caustic solutions, dilute acids, ketones and alcohols. Good abrasion resistance.

PTFE: Widest chemical compatibility, extreme corrosion resistance, non-adhesive, high heat resistance.

EXTRA LINE EPO THE P

Air operated double diaphragms pumps
Realized in:
PP, PVDF, ALUMINIUM, SS AISI 316, POMc
Flow-rate from 8lt/min to 1.000 lt/min
Connection from ¼" to 3".
ATEX certification for zone 2
EX II 3/3 GD c IIB T135°C





PVDF+CF



POMc

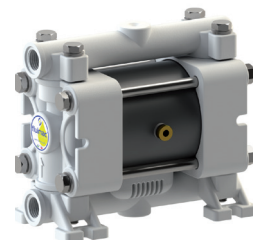

Technical data

Fluid connections:	1/4" BSP
Air connection:	4 mm
Max flow-rate:	8 lt/min
Max air pressure:	8 bar
Max delivery head:	80 m
Max Suction Lift Dry:	3 m
Max Suction Lift Wet:	9,8 m
Max Solid passing:	2,5 mm
Noise level:	62 dB
Max Viscosity:	6.000 cps

 EX II 3/3 GD c IIB T 135°C

Performance

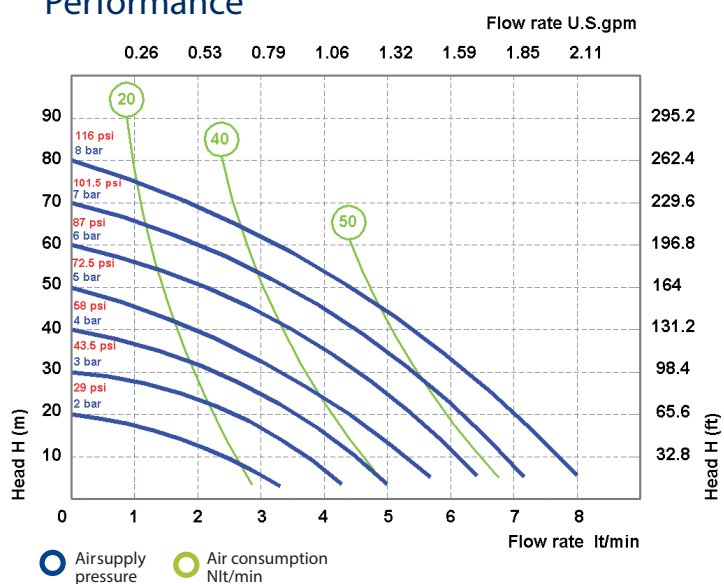

The curves and performance values refer to pumps with submerged suction and a free delivery outlet with water at 20°C, and vary according to the construction material.

Dimensions

	PP	PVDF	POMc
A (mm)	129	129	129
B (mm)	68	68	68
C (mm)	112	112	112
Weight kg	0,7	0,9	0,9
MAX Temperature	65°C	95°C	80°C
MIN Temperature	-4°C	-20°C	-5°C

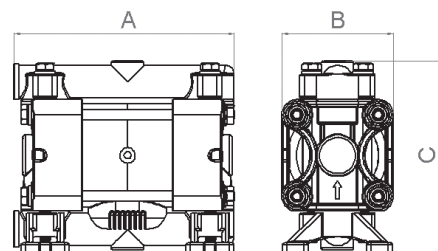

Composition

MODEL	CASING	DIAPHRAGM	BALLS	SEATS	GASKET	CONNECTIONS	ATEX	PORTS
P0007	P = PP KC = PVDF+CF O = POMc	NT = NBR+PTFE	T = PTFE S = SS	P = PP K = PVDF O = POMc	D = EPDM V = VITON N = NBR T = PTFE	1 = BSP 5 = NPT	- = zone 2	AB = STANDARD

PP



PVDF+CF



POMc



AISI 316



Technical data

Fluid connections:	3/8" BSP
Air connection:	6 mm
Max flow-rate:	20 lt/min
Max air pressure:	8 bar
Max delivery head:	80 m
Max Suction Lift Dry:	6 m
Max Suction Lift Wet:	9,8 m
Max Solid passing:	3 mm
Noise level:	65 dB
Max viscosity:	12.000 cps

 EX II 3/3 GD c IIB T 135°C

Performance

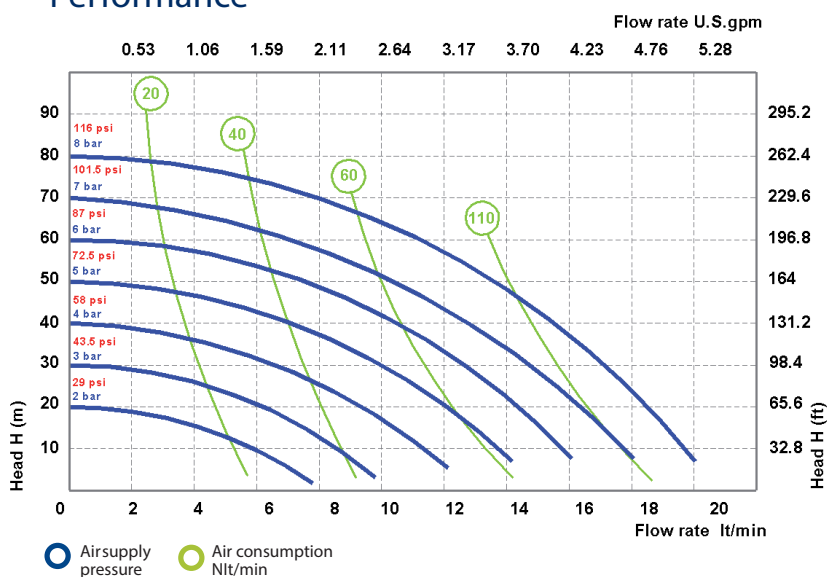

The curves and performance values refer to pumps with submerged suction and a free delivery outlet with water at 20°C, and vary according to the construction material.

Dimensions

	PP	PVDF	POMc	AISI 316
A (mm)	146	146	146	148
B (mm)	96	96	96	92
C (mm)	164	164	164	153
Weight kg	1,1	1,4	1,1	2,1
MAX Temperature	65°C	95°C	80°C	95°C
MIN Temperature	-4°C	-20°C	-5°C	-20°C

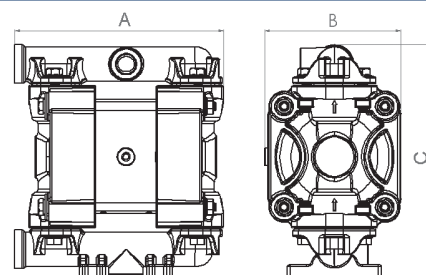

Composition

MODEL	CASING	DIAPHRAGM	BALLS	SEATS	GASKET	CONNECTIONS	ATEX	PORTS
P0018	P = PP KC = PVDF+CF O = POMc S = SS	HT = HYTREL+PTFE MT = SANTOPRENE+PTFE H = HYTREL M = SANTOPRENE	T = PTFE S = SS D = EPDM N = NBR	P = PP K = PVDF O = POMc S = SS Z = PE-UHMWE	D = EPDM V = VITON N = NBR T = PTFE	1 = BSP 2 = FLANGED 5 = NPT	-- zone 2	AB = STANDARD

Phoenix P30

PP



PVDF+CF



POMc

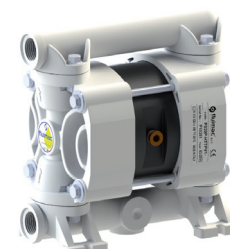

AISI 316



Technical data

Fluid connections:	1/2" BSP
Air connection:	6 mm
Max flow-rate:	35 lt/min
Max air pressure:	8 bar
Max delivery head:	80 m
Max Suction Lift Dry:	5 m
Max Suction Lift Wet:	9,8 m
Max Solid passing:	3,5 mm
Noise level:	65 dB
Max Viscosity:	15.000 cps

 EX II 3/3 GD c IIB T 135°C

Performance

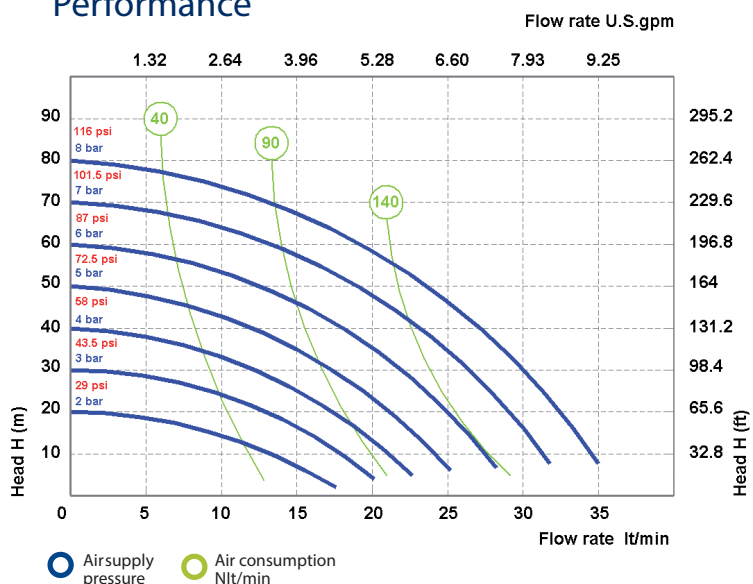

The curves and performance values refer to pumps with submerged suction and a free delivery outlet with water at 20°C, and vary according to the construction material.

Dimensions

	PP	PVDF	POMc	AISI
A (mm)	177	177	177	182
B (mm)	105	105	105	104
C (mm)	183	183	183	190
Weight kg	1,4	1,7	1,4	2,4
MAX Temperature	65°C	95°C	80°C	95°C
MIN Temperature	-4°C	-20°C	-5°C	-20°C

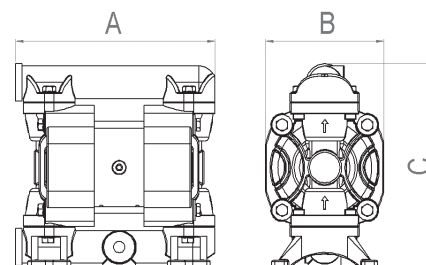

Composition

MODEL	CASING	DIAPHRAGM	BALLS	SEATS	GASKET	CONNECTIONS	ATEX	PORTS
P0030	P = PP KC = PVDF+CF O = POMc S = SS	HT = HYTREL+PTFE MT = SANTOPRENE+PTFE H = HYTREL M = SANTOPRENE	T = PTFE S = SS D = EPDM N = NBR	P = PP K = PVDF O = POMc S = SS Z = PE-UHMWE	D = EPDM V = VITON N = NBR T = PTFE	1 = BSP 2 = FLANGED 5 = NPT	-- zone 2	AB = STANDARD

Phoenix P50

PP



PVDF+CF



ALU



AISI 316



Technical data

Fluid connections:	1/2" BSP
Air connection:	1/4" BSP
Max flow-rate:	55 lt/min
Max air pressure:	8 bar
Max delivery head:	80 m
Max Suction Lift Dry:	6 m
Max Suction Lift Wet:	9,8 m
Max Solid passing:	3,5 mm
Noise level:	68 dB
Max Viscosity:	20.000 cps

 EX II 3/3 GD c IIB T 135°C

Performance

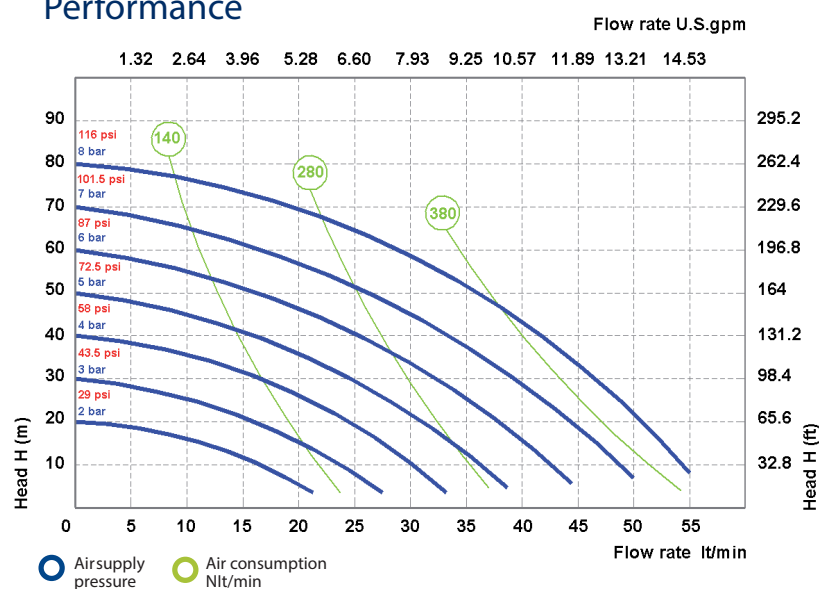

The curves and performance values refer to pumps with submerged suction and a free delivery outlet with water at 20°C, and vary according to the construction material.

Dimensions

	PP	PVDF	ALU	AISI
A (mm)	222	222	225	225
B (mm)	156	156	156	156
C (mm)	233	233	230	230
Weight kg	4	4,5	5	6
MAX Temperature	65°C	95°C	90°C	95°C
MIN Temperature	-4°C	-20°C	-20°C	-20°C

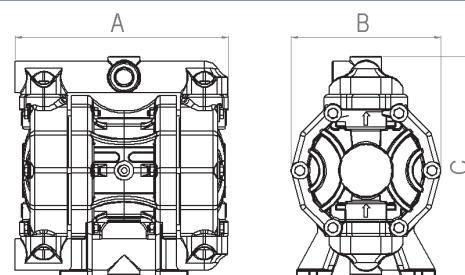

Composition

MODEL	CASING	DIAPHRAGM	BALLS	SEATS	GASKET	CONNECTIONS	ATEX	PORTS
P0050	P = PP KC = PVDF+CF A = ALU S = SS	HT = HYTREL+PTFE MT = SANTOPRENE+PTFE H = HYTREL M = SANTOPRENE D = EPDM N = NBR	T = PTFE S = SS D = EPDM N = NBR	P = PP K = PVDF A = ALU S = SS Z = PE-UHMWE	D = EPDM V = VITON N = NBR T = PTFE	1 = BSP 2 = FLANGED 5 = NPT	-- zone 2	AB = STANDARD

PP



PVDF+CF



ALU



AISI 316



Technical data

Fluid connections:	1/2" BSP
Air connection:	3/8" BSP
Max flow-rate:	70 lt/min
Max air pressure:	8 bar
Max delivery head:	80 m
Max Suction Lift Dry:	6 m
Max Suction Lift Wet:	9,8 m
Max Solid passing:	3,5 mm
Noise level:	72 dB
Max Viscosity:	25.000 cps

 EX II 3/3 GD c IIB T 135°C

Performance

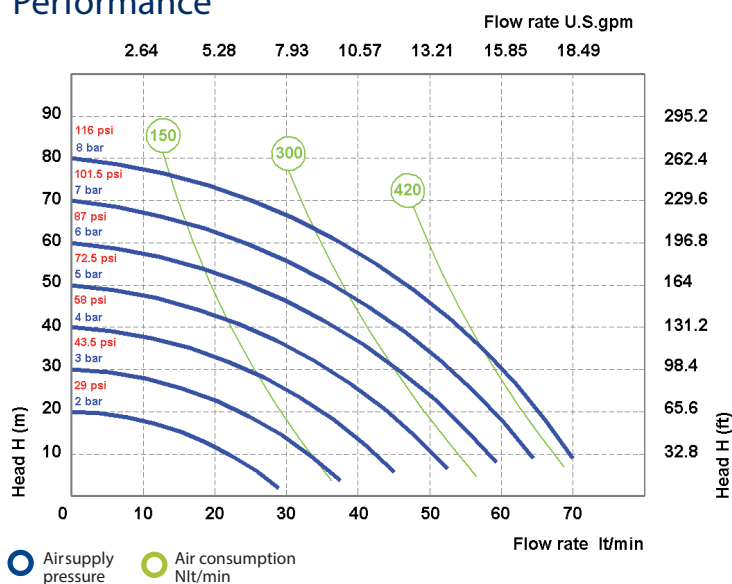

The curves and performance values refer to pumps with submerged suction and a free delivery outlet with water at 20°C, and vary according to the construction material.

Dimensions

	PP	PVDF	ALU	AISI
A (mm)	265	265	265	250
B (mm)	175	175	175	175
C (mm)	245	245	245	250
Weight kg	6,5	7	7	9
MAX Temperature	65°C	95°C	90°C	95°C
MIN Temperature	-4°C	-20°C	-20°C	-20°C

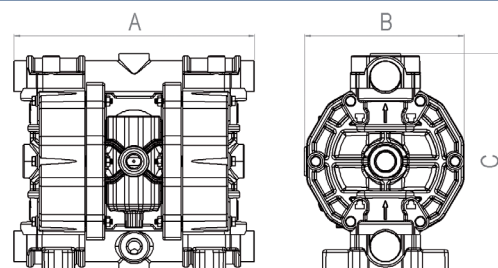

Composition

MODEL	CASING	DIAPHRAGM	BALLS	SEATS	GASKET	CONNECTIONS	ATEX	PORTS
P0065	P = PP KC = PVDF+CF A = ALU S = SS	HT = HYTREL+PTFE MT = SANTOPRENE+PTFE H = HYTREL M = SANTOPRENE D = EPDM N = NBR	T = PTFE S = SS D = EPDM N = NBR	P = PP K = PVDF A = ALU S = SS Z = PE-UHMWE	D = EPDM V = VITON N = NBR T = PTFE	1 = BSP 2 = FLANGED 5 = NPT	- = zone 2	AB = STANDARD

Phoenix P100

PP



PVDF+CF



ALU



AISI 316



Technical data

Fluid connections:	3/4" BSP
Air connection:	3/8" BSP
Max flow-rate:	110 lt/min
Max air pressure:	8 bar
Max delivery head:	80 m
Max Suction Lift Dry:	6 m
Max Suction Lift Wet:	9,8 m
Max Solid passing:	3,5 mm
Noise level:	72 dB
Max Viscosity:	25.000 cps

 EX II 3/3 GD c IIB T 135°C

Performance

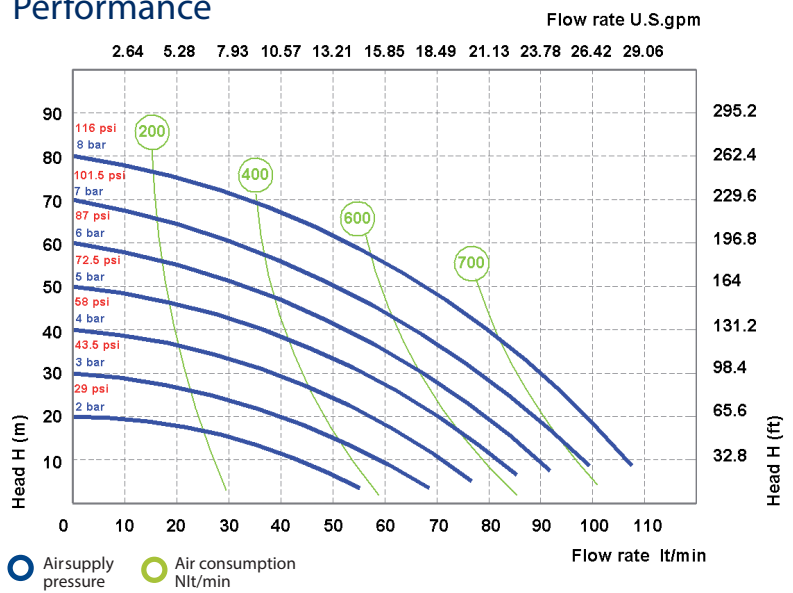

The curves and performance values refer to pumps with submerged suction and a free delivery outlet with water at 20°C, and vary according to the construction material.

Dimensions

	PP	PVDF	ALU	AISI
A (mm)	265	265	265	250
B (mm)	175	175	175	175
C (mm)	245	245	245	250
Weight kg	6,5	7	7	9
MAX Temperature	65°C	95°C	90°C	95°C
MIN Temperature	-4°C	-20°C	-20°C	-20°C

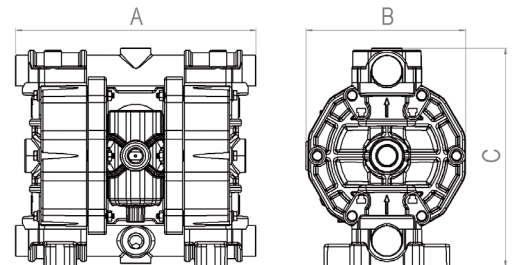

Composition

MODEL	CASING	DIAPHRAGM	BALLS	SEATS	GASKET	CONNECTIONS	ATEX	PORTS
P0100	P = PP KC = PVDF+CF A = ALU S = SS	HT = HYTREL+PTFE MT = SANTOPRENE+PTFE H = HYTREL M = SANTOPRENE D = EPDM N = NBR	T = PTFE S = SS D = EPDM N = NBR	P = PP K = PVDF A = ALU S = SS Z = PE-UHMWE	D = EPDM V = VITON N = NBR T = PTFE	1 = BSP 2 = FLANGED 5 = NPT	- = zone 2	AB = STANDARD

Phoenix P160

PP



PVDF+CF



ALU



AISI 316



Technical data

Fluid connections:	1" BSP
Air connection:	1/2" BSP
Max flow-rate:	170 lt/min
Max air pressure:	8 bar
Max delivery head:	80 m
Max Suction Lift Dry:	6 m
Max Suction Lift Wet:	9,8 m
Max Solid passing:	7,5 mm
Noise level:	75 dB
Max Viscosity:	35.000 cps

 EX II 3/3 GD c IIB T 135°C

Performance

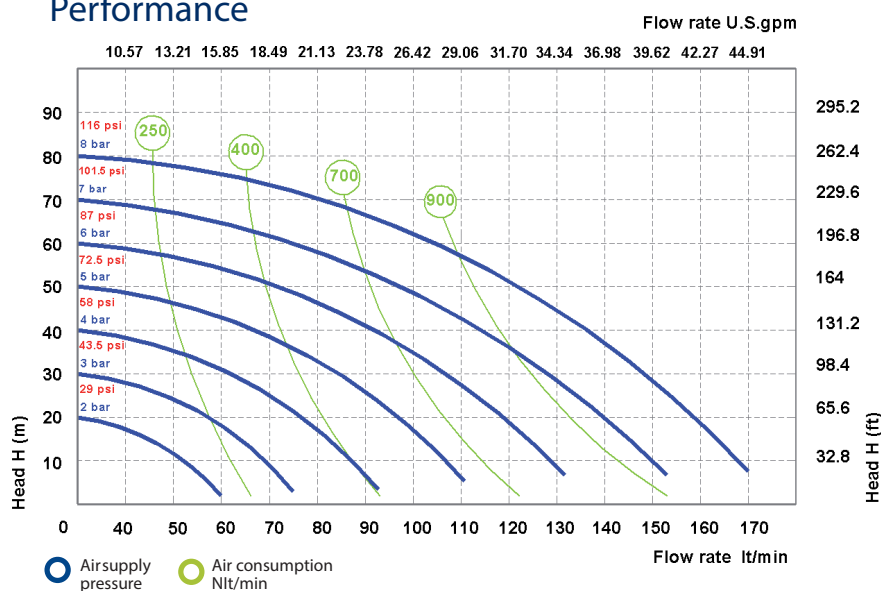

Dimensions

	PP	PVDF	ALU	AISI
A (mm)	370	370	370	360
B (mm)	222	222	222	222
C (mm)	370	370	364	346
Weight kg	15	16	16	20
MAX Temperature	65°C	95°C	90°C	95°C
MIN Temperature	-4°C	-20°C	-20°C	-20°C

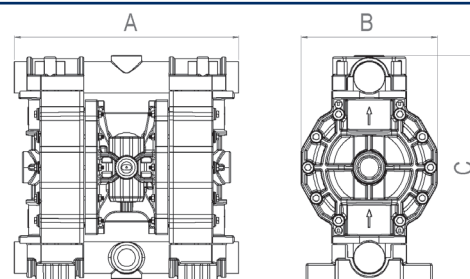

Composition

MODEL	CASING	DIAPHRAGM	BALLS	SEATS	GASKET	CONNECTIONS	ATEX	PORTS
P0160	P = PP KC = PVDF+CF A = ALU S = SS	HT = HYTREL+PTFE MT = SANTOPRENE+PTFE H = HYTREL M = SANTOPRENE D = EPDM N = NBR	T = PTFE S = SS D = EPDM N = NBR	P = PP K = PVDF A = ALU S = SS Z = PE-UHMWE	D = EPDM V = VITON N = NBR T = PTFE	1 = BSP 2 = FLANGED 5 = NPT	- = zone 2	AB = STANDARD

Phoenix P250

PP



PVDF+CF



ALU



AISI 316



Technical data

Fluid connections:	1" 1/4 BSP
Air connection:	1/2" BSP
Max flow-rate:	250 lt/min
Max air pressure:	8 bar
Max delivery head:	80 m
Max Suction Lift Dry:	6 m
Max Suction Lift Wet:	9,8 m
Max Solid passing:	7,5 mm
Noise level:	75 dB
Max Viscosity:	35.000 cps

 EX II 3/3 GD c IIBT 135°C

Performance

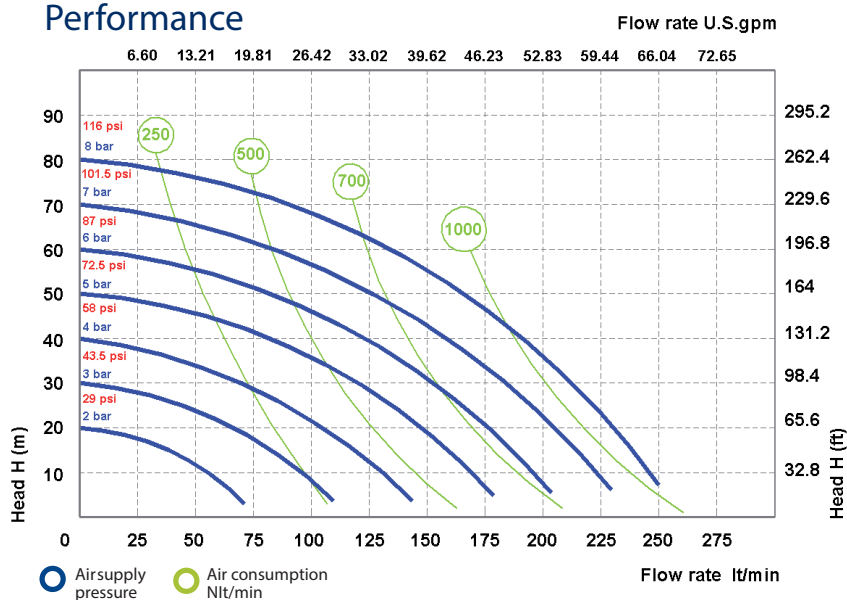

The curves and performance values refer to pumps with submerged suction and a free delivery outlet with water at 20°C, and vary according to the construction material.

Dimensions

	PP	PVDF	ALU	AISI
A (mm)	370	370	370	360
B (mm)	222	222	222	222
C (mm)	370	370	364	346
Weight kg	15	16	16	20
MAX Temperature	65°C	95°C	90°C	95°C
MIN Temperature	-4°C	-20°C	-20°C	-20°C

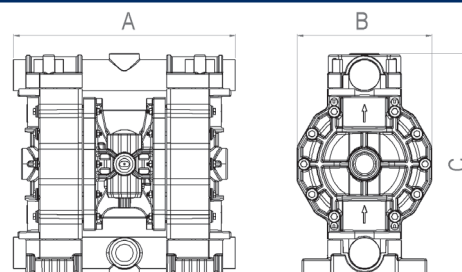

Composition

MODEL	CASING	DIAPHRAGM	BALLS	SEATS	GASKET	CONNECTIONS	ATEX	PORTS
P0250	P = PP KC = PVDF+CF A = ALU S = SS	HT = HYTREL+PTFE MT = SANTOPRENE+PTFE H = HYTREL M = SANTOPRENE D = EPDM N = NBR	T = PTFE S = SS D = EPDM N = NBR	P = PP K = PVDF A = ALU S = SS Z = PE-UHMWE	D = EPDM V = VITON N = NBR T = PTFE	1 = BSP 2 = FLANGED 5 = NPT	- = zone 2	AB = STANDARD

PP

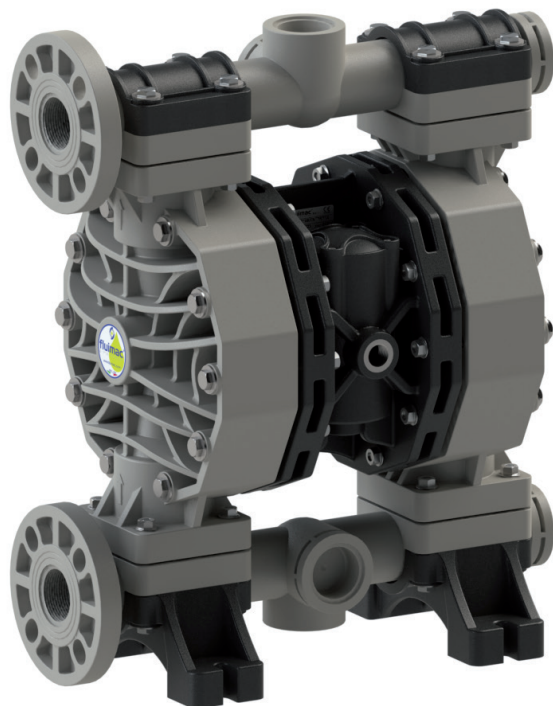

PVDF+CF



ALU

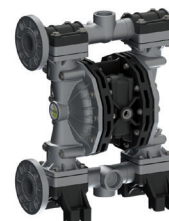

AISI 316



Technical data

Fluid connections:	1" 1/2 BSP DN 40
Air connection:	3/4" BSP
Max flow-rate:	380 lt/min
Max air pressure:	8 bar
Max delivery head:	80 m
Max Suction Lift Dry:	5 m
Max Suction Lift Wet:	9,8 m
Max Solid passing:	8 mm
Noise level:	78 dB
Max Viscosity:	40.000 cps

 EX II 3/3 GD c IIB T 135°C

Performance

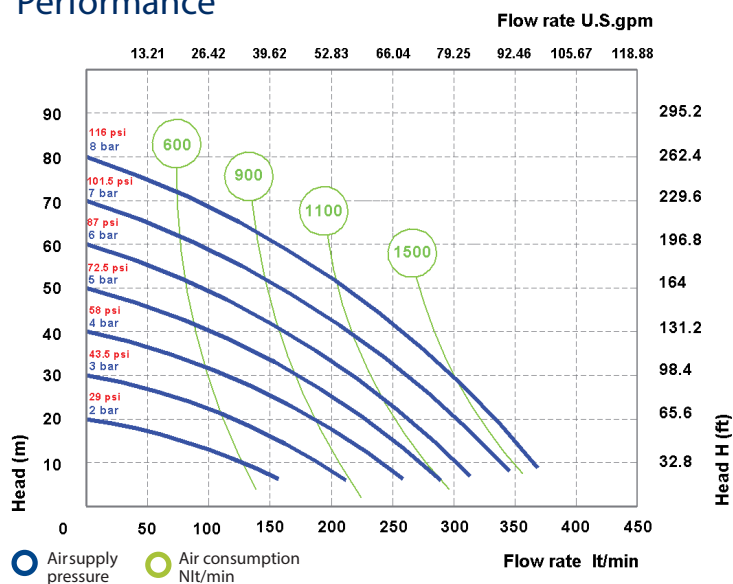

The curves and performance values refer to pumps with submerged suction and a free delivery outlet with water at 20°C, and vary according to the construction material.

Dimensions

	PP	PVDF	ALU	AISI
A (mm)	454	454	443	361
B (mm)	260	260	260	260
C (mm)	562	562	562	502
Weight kg	18	22	22	40
MAX Temperature	65°C	95°C	90°C	95°C
MIN Temperature	-4°C	-20°C	-20°C	-20°C

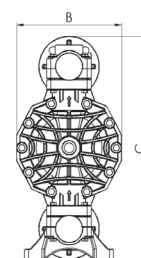
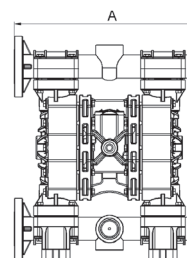

Composition

MODEL	CASING	DIAPHRAGM	BALLS	SEATS	GASKET	CONNECTIONS	ATEX	PORTS
P0400	P = PP KC = PVDF+CF A = ALU S = SS	HT = HYTREL+PTFE MT = SANTOPRENE+PTFE H = HYTREL M = SANTOPRENE D = EPDM N = NBR	T = PTFE S = SS D = EPDM N = NBR	P = PP K = PVDF A = ALU S = SS Z = PE-UHMWE	D = EPDM V = VITON N = NBR T = PTFE	1 = BSP 2 = FLANGED 5 = NPT	- = zone 2	AB = STANDARD EF = STANDARD AISI 316

Phoenix P500

PP



PVDF+CF



ALU



AISI 316



Technical data

Fluid connections:	1" 1/2 BSP DN 40
Air connection:	3/4" BSP
Max flow-rate:	550 lt/min
Max air pressure:	8 bar
Max delivery head:	80 m
Max Suction Lift Dry:	5 m
Max Suction Lift Wet:	9,8 m
Max Solid passing:	8,5 mm
Noise level:	78 dB
Max Viscosity:	50.000 cps

 EX II 3/3 GD c IIB T 135°C

Performance

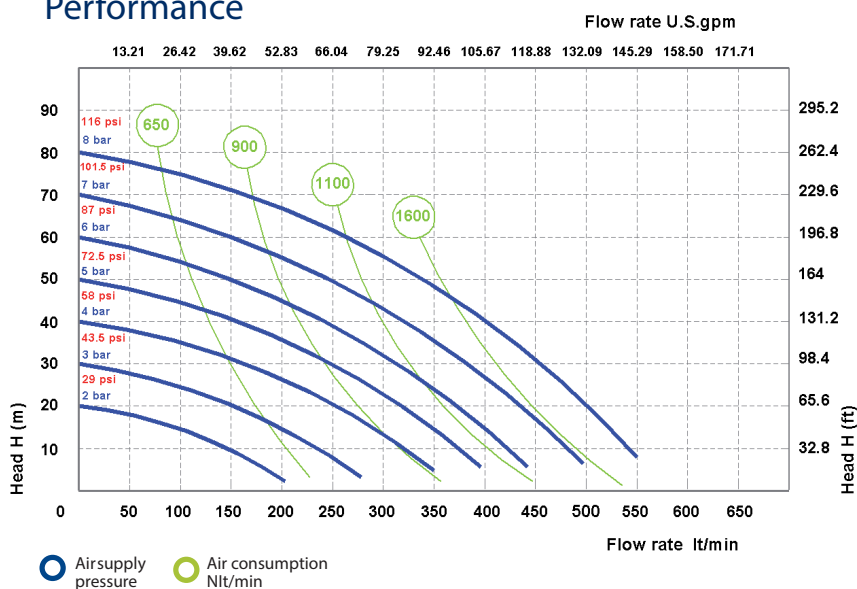

The curves and performance values refer to pumps with submerged suction and a free delivery outlet with water at 20°C, and vary according to the construction material.

Dimensions

	PP	PVDF	ALU	AISI
A (mm)	595	595	595	582
B (mm)	345	345	345	345
C (mm)	565	565	560	570
Weight kg	31	36	36	60
MAX Temperature	65°C	95°C	90°C	95°C
MIN Temperature	-4°C	-20°C	-20°C	-20°C

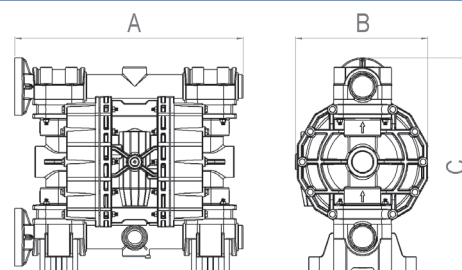

Composition

MODEL	CASING	DIAPHRAGM	BALLS	SEATS	GASKET	CONNECTIONS	ATEX	PORTS
P0500	P = PP KC = PVDF+CF A = ALU S = SS	HT = HYTREL+PTFE MT = SANTOPRENE+PTFE H = HYTREL M = SANTOPRENE D = EPDM N = NBR	T = PTFE S = SS D = EPDM N = NBR	P = PP K = PVDF A = ALU S = SS Z = PE-UHMWE	D = EPDM V = VITON N = NBR T = PTFE	1 = BSP 2 = FLANGED 5 = NPT	- = zone 2	AB = STANDARD EF = STANDARD AISI 316

PP



PVDF+CF



ALU



AISI 316



Technical data

Fluid connections:	2" BSP DN 50
Air connection:	3/4" BSP
Max flow-rate:	700 lt/min
Max air pressure:	8 bar
Max delivery head:	80 m
Max Suction Lift Dry:	5 m
Max Suction Lift Wet:	9,8 m
Max Solid passing:	8,5 mm
Noise level:	78 dB
Max Viscosity:	50.000 cps

 EX II 3/3 GD c IIB T 135°C

Performance

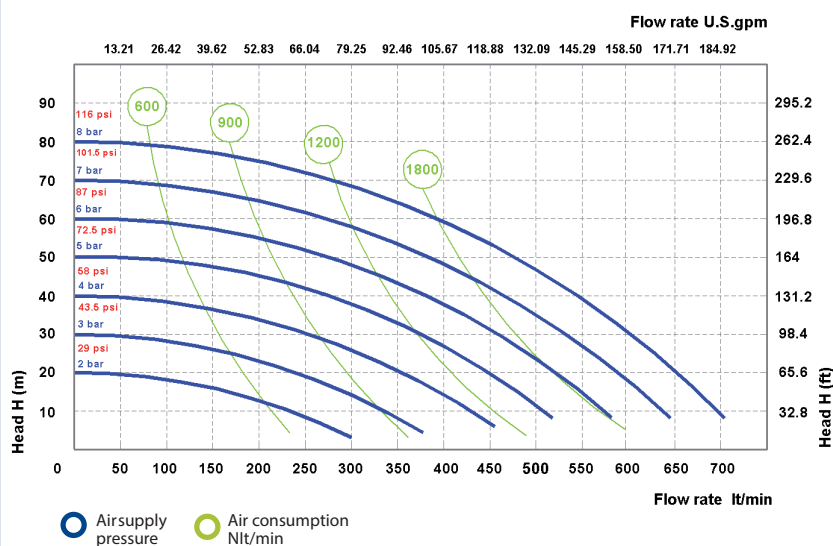

The curves and performance values refer to pumps with submerged suction and a free delivery outlet with water at 20°C, and vary according to the construction material.

Dimensions

	PP	PVDF	ALU	AISI
A (mm)	595	595	595	487
B (mm)	345	345	345	345
C (mm)	565	565	560	599
Weight kg	31	36	36	46
MAX Temperature	65°C	95°C	90°C	95°C
MIN Temperature	-4°C	-20°C	-20°C	-20°C

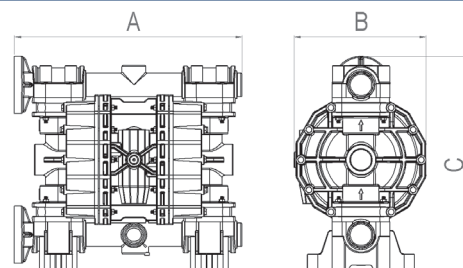

Composition

MODEL	CASING	DIAPHRAGM	BALLS	SEATS	GASKET	CONNECTIONS	ATEX	PORTS
P0700	P = PP KC = PVDF+CF A = ALU	HT = HYTREL+PTFE MT = SANTOPRENE+PTFE H = HYTREL M = SANTOPRENE D = EPDM N = NBR	T = PTFE S = SS D = EPDM N = NBR	P = PP K = PVDF A = ALU S = SS Z = PE-UHMWE	D = EPDM V = VITON N = NBR T = PTFE	1 = BSP 2 = FLANGED 5 = NPT	- = zone 2	AB = STANDARD EF = STANDARD AISI 316
PN700	S = SS							

Phoenix P1000



PP

PVDF



ALU



AISI 316



Technical data

Fluid connections:	3" BSP DN 80
Air connection:	3/4" BSP
Max flow-rate:	1050 lt/min
Max air pressure:	8 bar
Max delivery head:	80 m
Max Suction Lift Dry:	5 m
Max Suction Lift Wet:	9,8 m
Max Solid passing:	10 mm
Noise level:	78 dB
Max Viscosity:	55.000 cps

 EX II 3/3 GD c IIB T 135°C

Performance

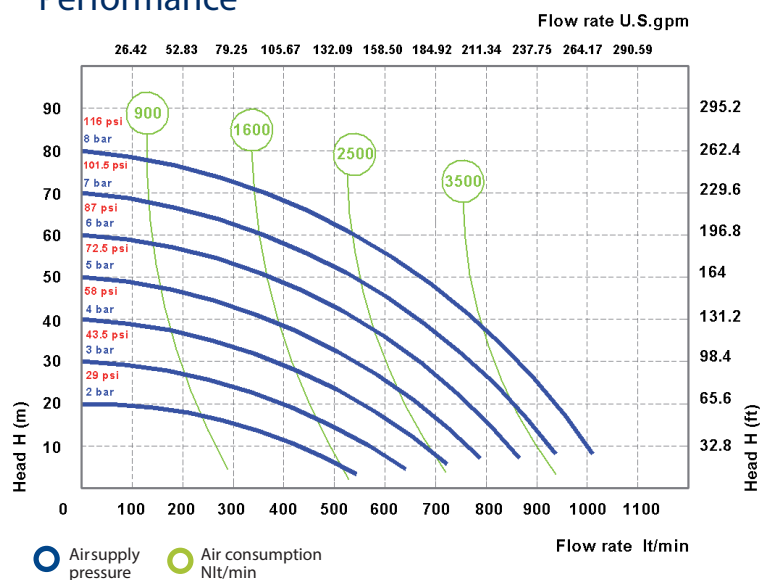

The curves and performance values refer to pumps with submerged suction and a free delivery outlet with water at 20°C, and vary according to the construction material.

Dimensions

	PP	PVDF	ALU	AISI
A (mm)	685	685	570	570
B (mm)	417	417	420	420
C (mm)	933	933	838	838
Weight kg	50	55	55	120
MAX Temperature	65°C	95°C	90°C	95°C
MIN Temperature	-4°C	-20°C	-20°C	-20°C

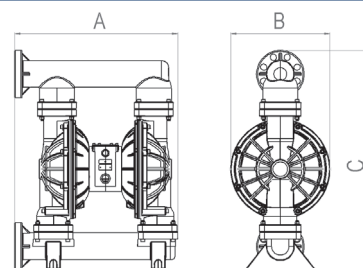

Composition

MODEL	CASING	DIAPHRAGM	BALLS	SEATS	GASKET	CONNECTIONS	ATEX	PORTS
P1000	P = PP K = PVDF A = ALU S = SS	MT = SANTOPRENE+PTFE H = HYTREL M = SANTOPRENE	T = PTFE S = SS D = EPDM N = NBR	P = PP K = PVDF A = ALU S = SS	D = EPDM V = VITON N = NBR T = PTFE	1 = BSP 2 = FLANGED	- = zone 2	AB = STANDARD



FOOD FOOD

FDA compliant



Air operated double diaphragms pumps
 Realized in:
 SS AISI 316 electro-polished and PP food grade (P7)
 Flow-rate from 8lt/min to 1.000 lt/min
 Tri-Clamp Connection.
 ATEX certification
 Atex zone 2 - EX II 3/3 GD c IIB T 135°C
 Atex zone 1 - EX II 2/2 GD c IIB T 135°C



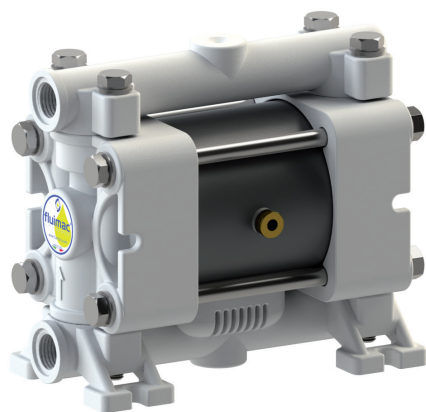

PP FOOD GRADE

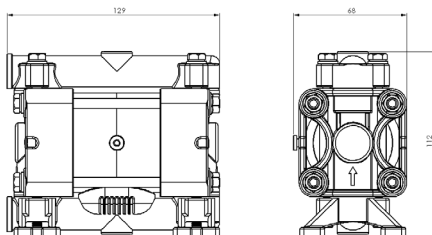

Technical data

Fluid connections: 1/4" BSP
Air connection: 4 mm
Max flow-rate: 8 lt/min
Max air pressure: 8 bar
Max viscosity: 6.000 cps

Performance

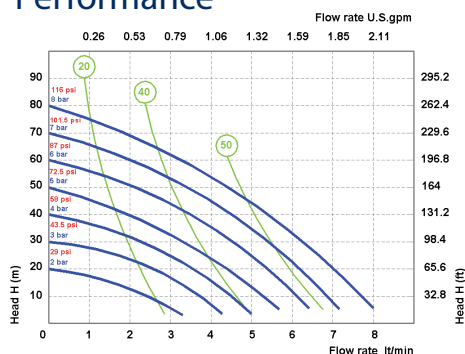

● Airsupply pressure ● Air consumption Nlt/min

The curves and performance values refer to pumps with submerged suction and a free delivery outlet with water at 20°C, and vary according to the construction material.

Composition

MODEL	CASING	DIAPHRAGM	BALLS	SEATS	GASKET	CONNECTIONS	ATEX	PORTS
PF0007	P = PP FOOD GRADE	NT = NBR+PTFE	T = PTFE S = SS	P = PP	T = PTFE	1 = BSP 5 = NPT	- = zone 2	AB = STANDARD



AINI 316 ELECTRO-POLISHED

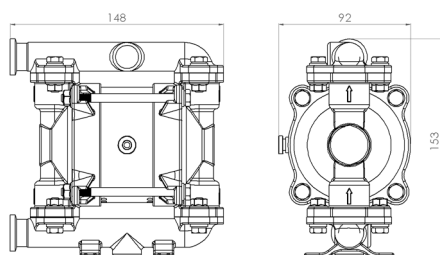

Technical data

Fluid connections: Tri-Clamp 1/2"
Air connection: 6 mm
Max flow-rate: 20 lt/min
Max air pressure: 8 bar
Max viscosity: 12.000 cps

Performance

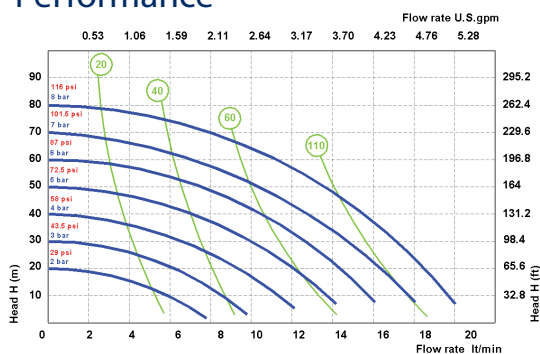

● Airsupply pressure ● Air consumption Nlt/min

The curves and performance values refer to pumps with submerged suction and a free delivery outlet with water at 20°C, and vary according to the construction material.

Composition

MODEL	CASING	DIAPHRAGM	BALLS	SEATS	GASKET	CONNECTIONS	ATEX	PORTS
PF0018	S = SS POLISHED	HT = HYTREL+PTFE	T = PTFE S = SS	P = PP	T = PTFE	3 = TRI-CLAMP 1 = BSP	- = zone 2 X = zone 1	AB = STANDARD

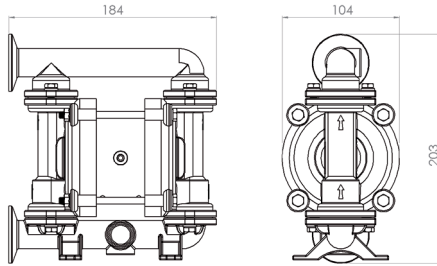

Technical data

Fluid connections: Tri-Clamp 1"
Air connection: 6 mm
Max flow-rate: 35 lt/min
Max air pressure: 8 bar
Max viscosity: 15.000 cps

Performance

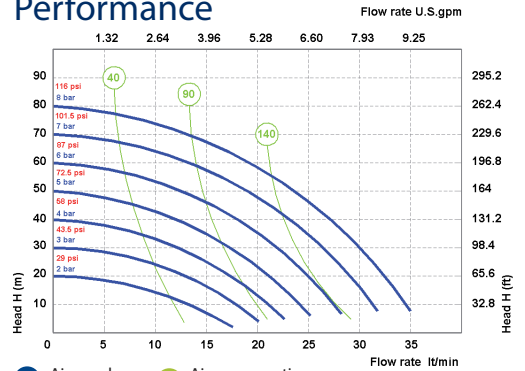

● Airsupply pressure ● Air consumption Nit/min
The curves and performance values refer to pumps with submerged suction and a free delivery outlet with water at 20°C, and vary according to the construction material.

Composition

MODEL	CASING	DIAPHRAGM	BALLS	SEATS	GASKET	CONNECTIONS	ATEX	PORTS
PF0030	S = SS POLISHED	HT = HYTREL+PTFE	T = PTFE S = SS	S = SS	T = PTFE	3 = TRI-CLAMP 1 = BSP	- = zone 2 X = zone 1	AB = STANDARD



AIISI 316 ELECTRO-POLISHED

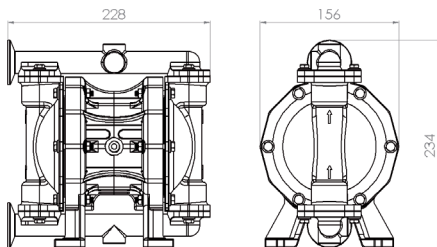

Technical data

Fluid connections: Tri-Clamp 1"
Air connection: 1/4" BSP
Max flow-rate: 55 lt/min
Max air pressure: 8 bar
Max viscosity: 20.000 cps

Performance

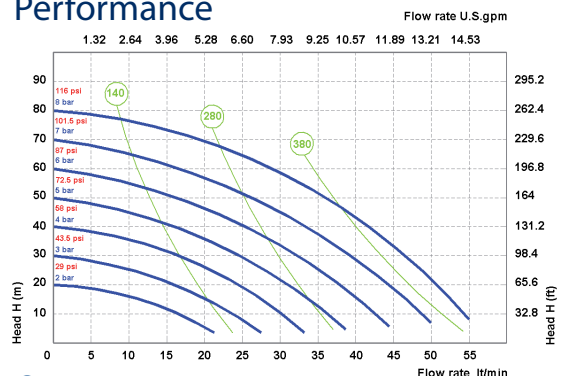

● Airsupply pressure ● Air consumption Nit/min
The curves and performance values refer to pumps with submerged suction and a free delivery outlet with water at 20°C, and vary according to the construction material.

Composition

MODEL	CASING	DIAPHRAGM	BALLS	SEATS	GASKET	CONNECTIONS	ATEX	PORTS
PF0050	S = SS POLISHED	HT = HYTREL+PTFE	T = PTFE S = SS	S = SS	T = PTFE	3 = TRI-CLAMP 1 = BSP	- = zone 2 X = zone 1	AB = STANDARD



Phoenix Food
PF100



AISI 316 ELECTRO-POLISHED

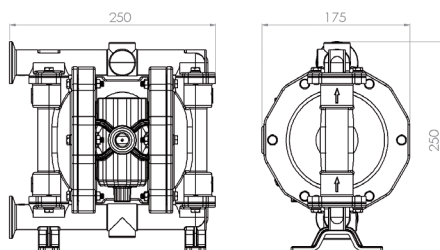

Technical data

Fluid connections: Tri-Clamp 1"
Air connection: 3/8" BSP
Max flow-rate: 110 lt/min
Max air pressure: 8 bar
Max viscosity: 25.000 cps

Performance

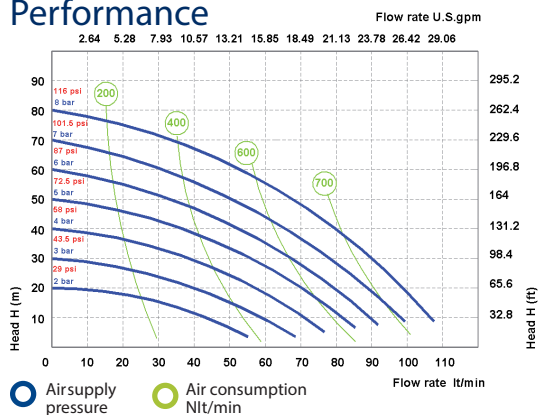

The curves and performance values refer to pumps with submerged suction and a free delivery outlet with water at 20°C, and vary according to the construction material.

Composition

MODEL	CASING	DIAPHRAGM	BALLS	SEATS	GASKET	CONNECTIONS	ATEX	PORTS
PF100	S = SS POLISHED	HT = HYTREL+PTFE	T = PTFE S = SS	S = SS	T = PTFE	3 = TRI-CLAMP 1 = BSP	- = zone 2 X = zone 1	AB = STANDARD



Phoenix Food
PF160

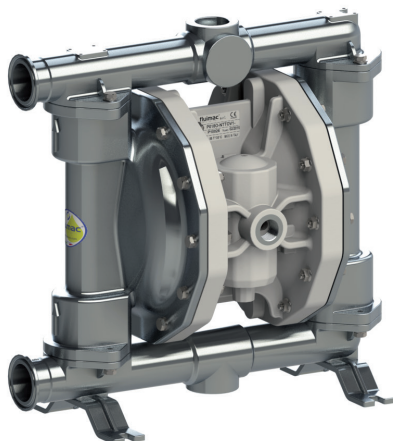

AISI 316 ELECTRO-POLISHED

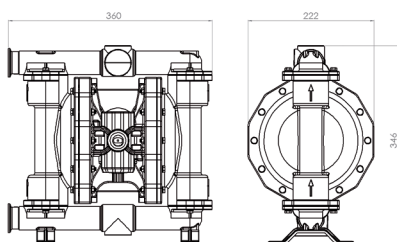

Technical data

Fluid connections: Tri-Clamp 1 1/2"
Air connection: 1/2" BSP
Max flow-rate: 170 lt/min
Max air pressure: 8 bar
Max viscosity: 35.000 cps

Performance

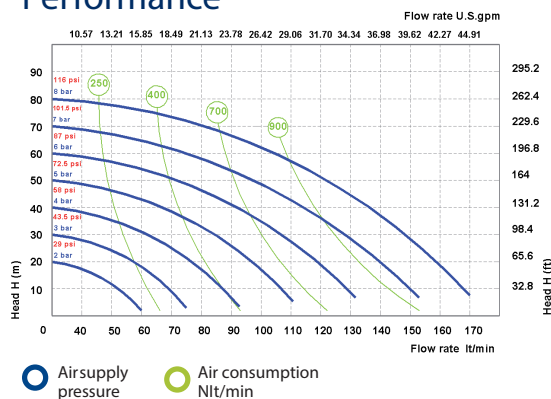

The curves and performance values refer to pumps with submerged suction and a free delivery outlet with water at 20°C, and vary according to the construction material.

Composition

MODEL	CASING	DIAPHRAGM	BALLS	SEATS	GASKET	CONNECTIONS	ATEX	PORTS
PF160	S = SS POLISHED	HT = HYTREL+PTFE	T = PTFE S = SS	S = SS	T = PTFE	3 = TRI-CLAMP 1 = BSP	- = zone 2 X = zone 1	AB = STANDARD



Phoenix Food
PF400



AISI 316 ELECTRO-POLISHED

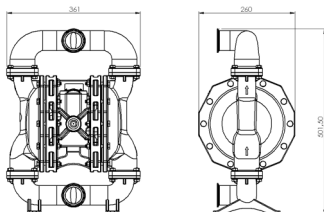

Technical data

Fluid connections: Tri-Clamp 2"
Air connection: 3/4" BSP
Max flow-rate: 380 lt/min
Max air pressure: 8 bar
Max viscosity: 40.000 cps

Performance

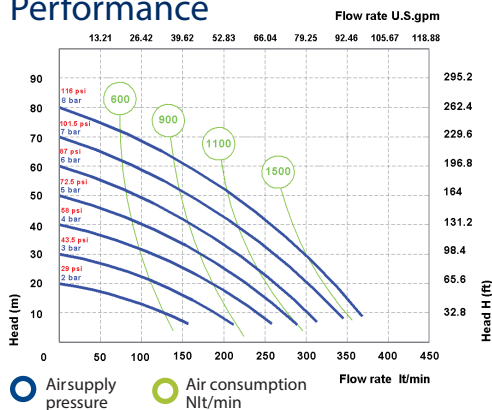

The curves and performance values refer to pumps with submerged suction and a free delivery outlet with water at 20°C, and vary according to the construction material.

Composition

MODEL	CASING	DIAPHRAGM	BALLS	SEATS	GASKET	CONNECTIONS	ATEX	PORTS
PF400	S = SS POLISHED	HT = HYTREL+PTFE	T = PTFE S = SS	S = SS	T = PTFE	3 = TRI-CLAMP 1 = BSP	- = zone 2 X = zone 1	EF = STANDARD



Phoenix Food
PF500

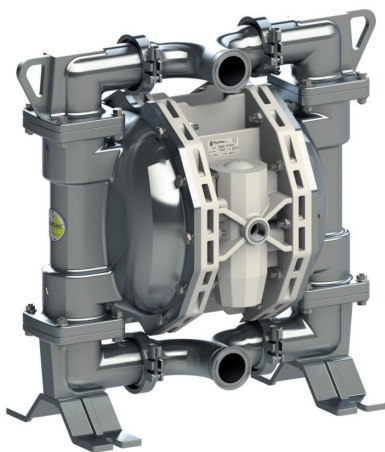

AISI 316 ELECTRO-POLISHED

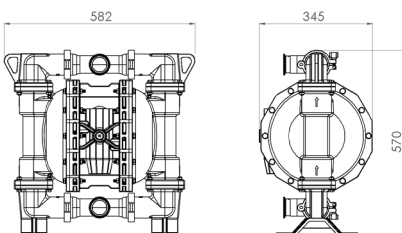

Technical data

Fluid connections: Tri-Clamp 2"
Air connection: 3/4" BSP
Max flow-rate: 550 lt/min
Max air pressure: 8 bar
Max viscosity: 50.000 cps

Performance

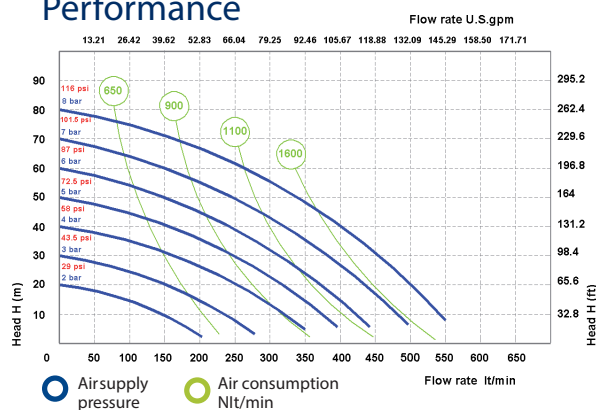

The curves and performance values refer to pumps with submerged suction and a free delivery outlet with water at 20°C, and vary according to the construction material.

Composition

MODEL	CASING	DIAPHRAGM	BALLS	SEATS	GASKET	CONNECTIONS	ATEX	PORTS
PF500	S = SS POLISHED	HT = HYTREL+PTFE	T = PTFE S = SS	S = SS	T = PTFE	3 = TRI-CLAMP 1 = BSP	- = zone 2 X = zone 1	EF = STANDARD

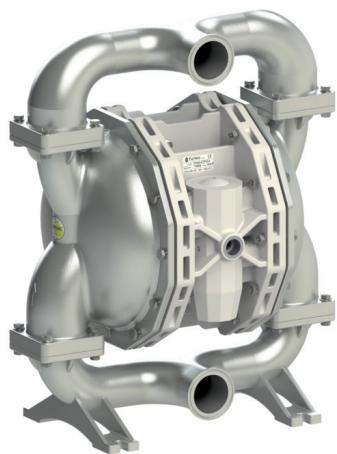

AISI 316 ELECTRO-POLISHED

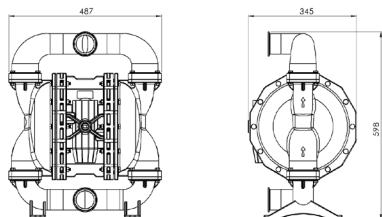

Technical data

Fluid connections: Tri-Clamp 2"1/2
 Air connection: 3/4" BSP
 Max flow-rate: 700 lt/min
 Max air pressure: 8 bar
 Max viscosity: 50.000 cps

Performance

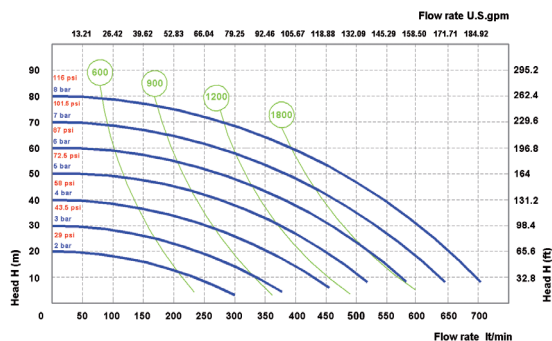

● Airsupply pressure ● Air consumption Nlt/min

The curves and performance values refer to pumps with submerged suction and a free delivery outlet with water at 20°C, and vary according to the construction material.

Composition

MODEL	CASING	DIAPHRAGM	BALLS	SEATS	GASKET	CONNECTIONS	ATEX	PORTS
PFN700	S = SS POLISHED	HT = HYTREL+PTFE	T = PTFE S = SS	S = SS	T = PTFE	3 = TRI-CLAMP 1 = BSP	- = zone 2 X = zone 1	EF = STANDARD



AISI 316 ELECTRO-POLISHED

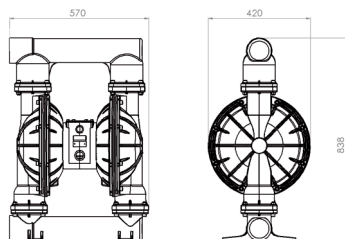

Technical data

Fluid connections: 3" BSP
 Air connection: 3/4" BSP
 Max flow-rate: 1050 lt/min
 Max air pressure: 8 bar
 Max viscosity: 55.000 cps

Performance

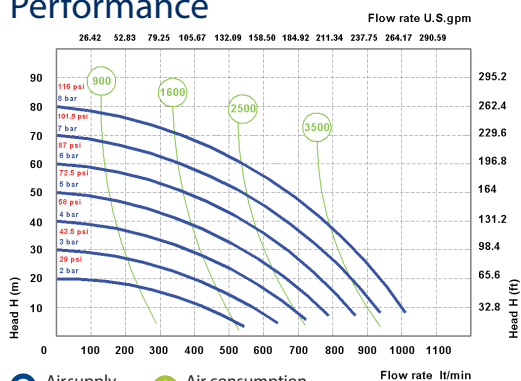

● Airsupply pressure ● Air consumption Nlt/min

The curves and performance values refer to pumps with submerged suction and a free delivery outlet with water at 20°C, and vary according to the construction material.

Composition

MODEL	CASING	DIAPHRAGM	BALLS	SEATS	GASKET	CONNECTIONS	ATEX	PORTS
PF1000	S = SS POLISHED	HT = HYTREL+PTFE	T = PTFE S = SS	S = SS	T = PTFE	3 = TRI-CLAMP 1 = BSP	- = zone 2 X = zone 1	AB = STANDARD

SPECIAL PUMPS

Air operated double diaphragms pumps
with special features:
PHOENIX ATEX certification zone1 ATEX
ACCURATE PHOENIX remote control
DRUM PHOENIX to empty drums and tanks
TWIN PHOENIX with double inlet/outlet





POMc+CF 



PP+CF 



PVDF+CF 



ALU 

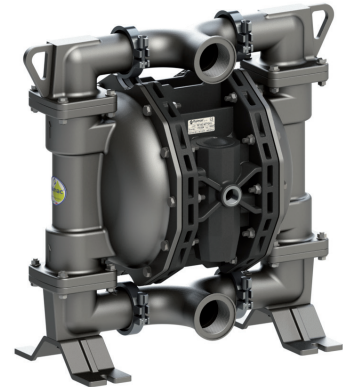

SS 



European ATEX Directive 94/9/CE

 II 2/2 GD c IIB T 135°C

 Safety symbols: DIN 40012 Annex A

II Equipment Group: surface

2/2 Equipment category: 2 Level of protection - High level - Zone 1

GD Type of explosive atmospheres (group II) G = Gas vapours -

D = Dust

c Equipment protection: constructional safety (EN 13463-5).

IIB Group of gas: IIB Ethylene. Exclusion of the following products:

Hydrogen, acetylene, carbon disulphide.

T 135° (T4) Temperature class (group II): Maximum surface temperature [°C] 135

PUMPS

7 - 18 - 30 - 50 - 65
100 - 160 - 250 - 400
500 - 700 - 1000

MAIN APPLICATIONS

- Petrol-Chemical Industry
- Painting industry
- Flexographic industry
- Automotive industry
- Food industry

Technical data

Fluimac has filed with the BUREAU VERITAS certification body the documentation certifying ATEX compliance pursuant to Directive 94/9/CE for its ranges of AODD pumps and pulsation dampeners, with special construction materials to have zone 1 certification.

Special Pumps
Accurate Phoenix

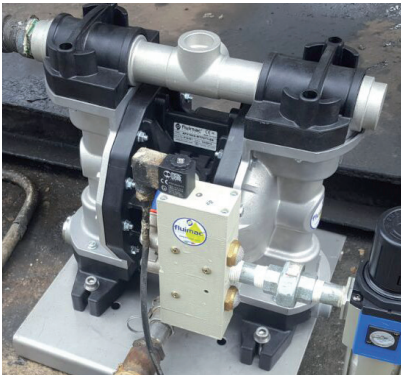
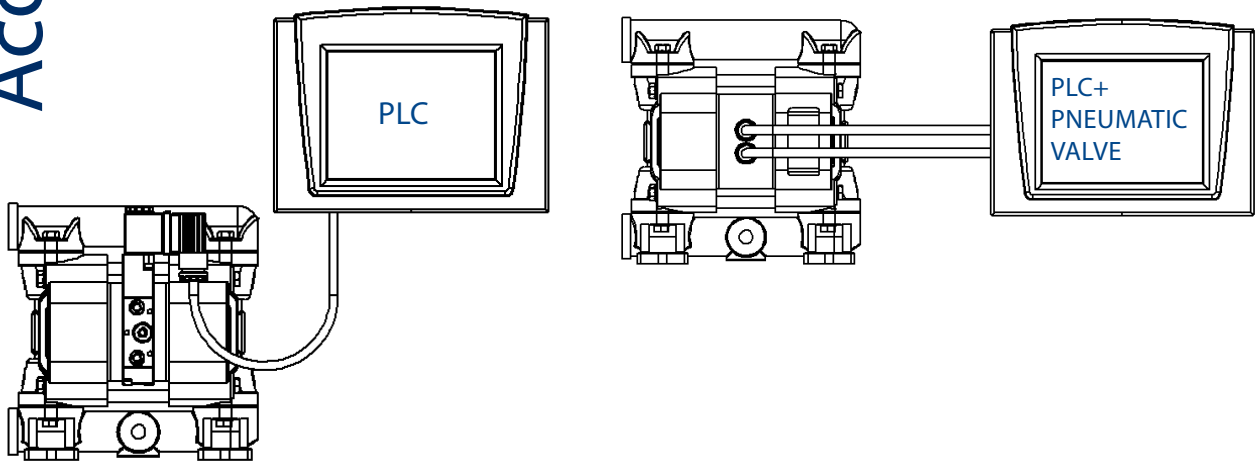

PUMPS

AP7 - AP18 - AP30
AP50 - AP65 - AP100
AP160 - AP250

MAIN APPLICATIONS

- Chemical industry
- Flexographic industry
- Painting industry
- Wastewater technology
- Printing industry

Technical data

ACCURATE PHOENIX are Pumps gives you the external pump control necessary for exacting applications such as batching. Featuring a direct electrical interface that utilizes electrical impulses to stroke the pump instead of differential pressure, the ACCURATE PHOENIX provides a variable stroke rate that you can easily control as needed.

Note: PLC and computer system not included.



PUMPS

DP18 - DP30 - DP50
DP65 - DP100
DP160

MAIN APPLICATIONS

- Chemical industry
- Waste disposal technology
- Automotive industry
- Food industry

Technical data

DRUM PHOENIX are designed for emptying drums and containers, and provide an economical and wear resistant alternative to other pumping systems. In order to handle a wide range of fluids, DP pumps are available in all materials. The pump can be quickly and easily mounted on the drum with its feet. The drum will be completely emptied with a suction pipe.



PUMPS

TP18 - TP30 - TP50
TP65 - TP100 - TP160
TP250 - TP400

MAIN APPLICATIONS

- Painting industry
- Wastewater technology
- Printing industry
- Paper processing
- Flexographic industry

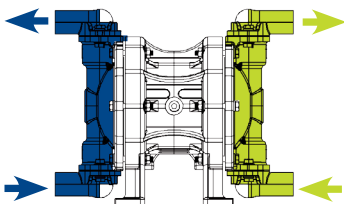

Technical data

TWIN PHOENIX are mainly used in the textile and paper processing industry. These dual action pumps are able to transfer two different media independently and simultaneously. This is accomplished by using separate connections on the suction and discharge ports, keeping two pumped media isolated from each other, preventing unwanted mixing.

DAMPERS

Pneumatic, automatic
pulsation dampeners
Realized in:
PP, PVDF, ALUMINIUM,
SS AISI 316, POMc
Applicable to all size
of pumps.
Available also in ATEX
or FOOD version.



DAMPER

The active pulsation dampener is the most efficient way to remove pressure variations on the discharge of the pump. **Fluimac** pulsation dampener works actively with compressed air and a diaphragm, automatically setting the correct pressure to minimize the pulsations. Pulsation dampeners require minimum maintenance and are, subject to the requirements of the application, available in the same housing and diaphragm materials as the pump.

Application

- Metering/ Injection/Dosing
- Equalizes discharge pressure spikes, increasing accuracy
- Filter Press/Inline Filters
- Increases filter efficiency and life by providing a smooth flow
- Spraying
- Smooth, consistent spray pattern.
- Filling
- Eliminates inconsistent filling and splashing.
- Transfer
- Eliminates harmful water hammer, preventing pipe and valve damage.

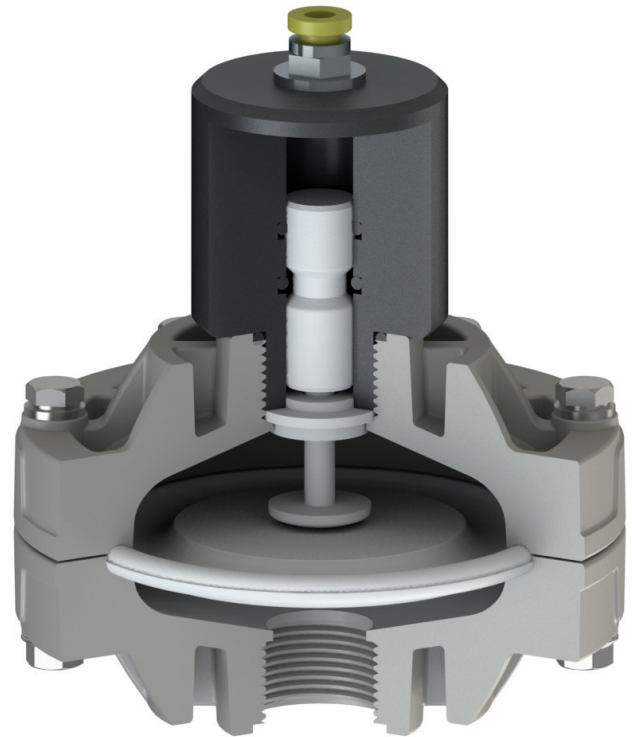

Significant Pulsation Reduction with an average 70% - 80% pulsation reduction in high back pressure applications.

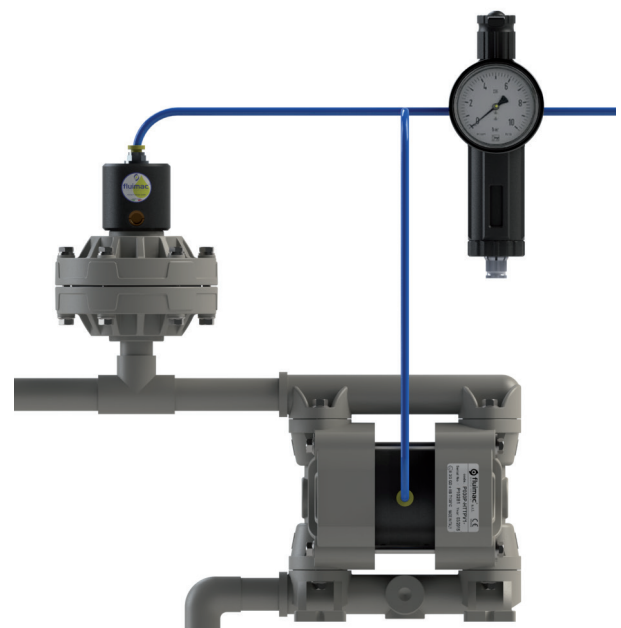
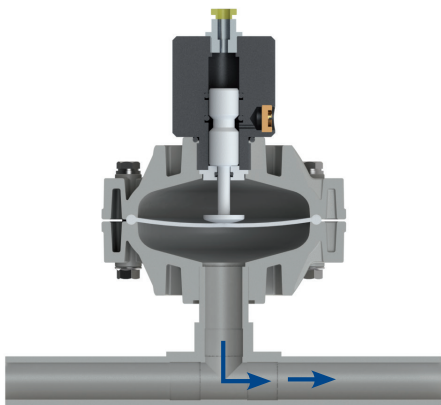
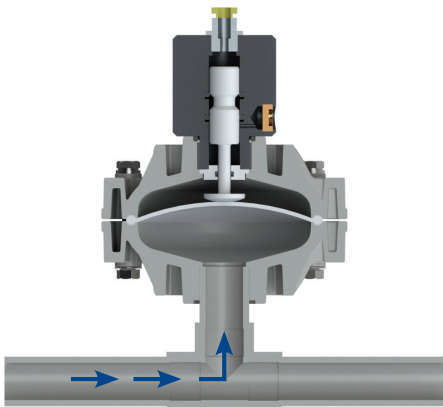

How it works

The pulsating flow of the discharge forces the diaphragm upwards where it is cushioned by the air in the chamber. The flexing of the diaphragm absorbs the pulsation giving a smooth flow.

Damper D20

Technical data

Fluid connections: 3/4"
Air connection: 6 mm
Max air pressure: 8 bar

APPLY TO:
7 - 18 - 30



PVDF+CF



POMc



AISI



Dimensions

	PP	PVDF	POMc	AISI
A (mm)	119	119	119	119
B (mm)	143	143	143	143
Weight kg	0,6	0,7	0,65	1,9
MAX Temperature	65°C	95°C	80°C	95°C
MIN Temperature	-4°C	-20°C	-5°C	-20°C

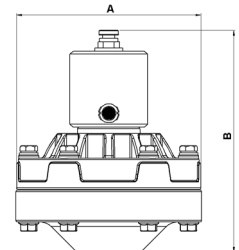
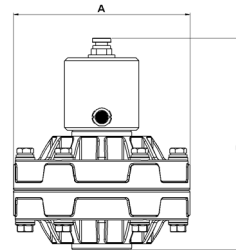

Damper D25

Technical data

Fluid connections: 1"
Air connection: 8 mm
Max air pressure: 8 bar

APPLY TO:
50 - 65 - 100



PVDF+CF

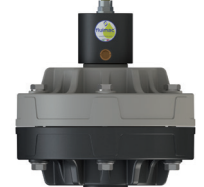

POMc



AISI

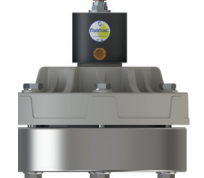

Dimensions

	PP	PVDF	POMc	AISI
A (mm)	181	181	181	181
B (mm)	195	195	195	182
Weight kg	1,6	2	1,9	6,5
MAX Temperature	65°C	95°C	80°C	95°C
MIN Temperature	-4°C	-20°C	-5°C	-20°C

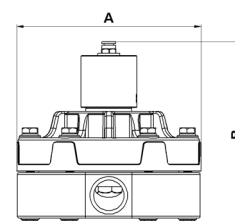
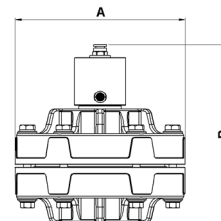

Damper D40

Technical data

Fluid connections: 1"1/2
Air connection: 10 mm
Max air pressure: 8 bar

APPLY TO:
160 - 250
400

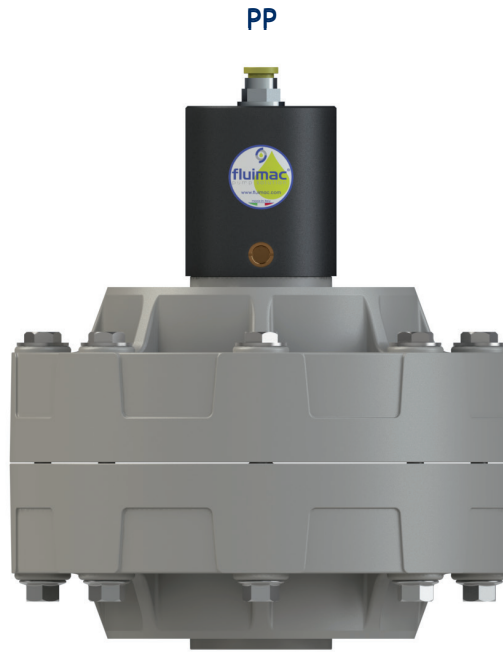

Dimensions

	PP	PVDF	POMc	AISI
A (mm)	233	233	233	233
B (mm)	270	270	270	275
Weight kg	3,8	4	3,9	5,9
MAX Temperature	65°C	95°C	80°C	95°C
MIN Temperature	-4°C	-20°C	-5°C	-20°C

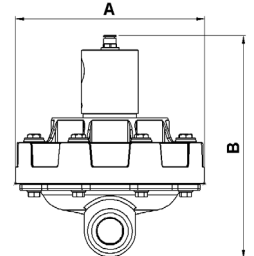
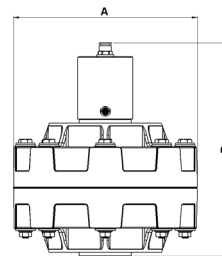

Damper D50

Technical data

Fluid connections: 2"
Air connection: 12 mm
Max air pressure: 8 bar

APPLY TO:
500 - 700
1000

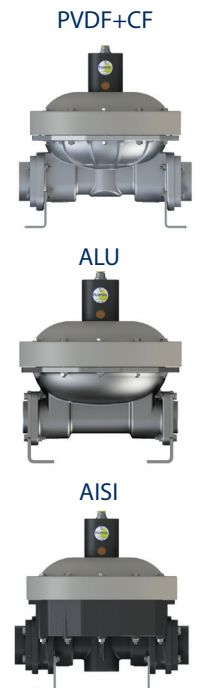

Dimensions

	PP	PVDF	ALU	AISI
A (mm)	404	404	404	350
B (mm)	420	420	420	418
Weight kg	13,7	17	14,3	21,6
MAX Temperature	65°C	95°C	90°C	95°C
MIN Temperature	-4°C	-20°C	-20°C	-20°C

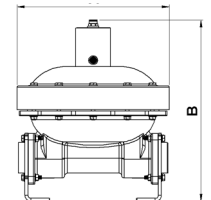
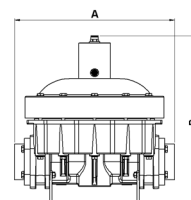

ACCESSORIES

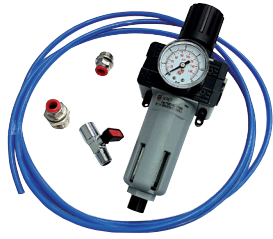

AIR REGULATION KIT
Adjust and set air pressure and air flow-rate with a filter regulator, pressure gauge and air valve unit.

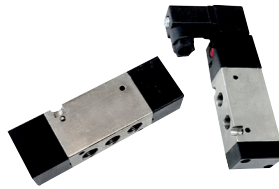

SWITCH VALVES
Remotely start and stop with a solenoid or pneumatic valve for the pump's air.

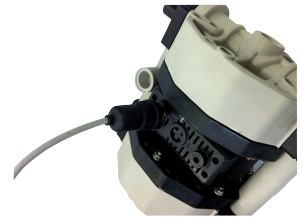

STROKE COUNTER
Count the number of strokes, connected to a control. It allows various type of monitoring.



DIAPHRAGM FAILURE DETECTION FLUI-GUARD
The Electronic Leak Detector provide a signal via warning lights, an audible alarm, and the pump can be shut down.



PNEUMATIC OR ELECTRONIC BATCH CONTROL
Pneumatic and electronic batcher can control any FLUIMAC AODD pump allowing you to set the cycles amount.



BASKET STRAINER FILTERS IN PP
Installed on the suction of the pumps, protects them from suspended solids and impurity.



INOX TROLLEY
It makes transportable pumps



ANTI VIBRATION FEET KIT
Reduces physical vibration from AODD pump operation.

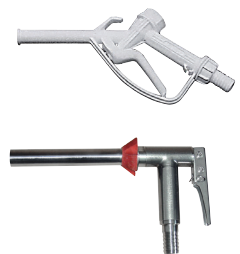

PP, PVDF, ALU, SS NOOZLE
Dispenser to delivery control and batching.



VALVES, FITTINGS AND CONNECTIONS IN PP, PVC, INOX



REINFORCED PVC HOSE
With metal reinforcement for suction/discharge, also food-grade.



FLANGE CONNECTION KIT
Adapt a pump from BSP type connection to flanges with this kit.





fluimac[®]
pump solution

in the
world



FLUIMAC S.r.l.

Via Po, angolo Via Tevere
21043, Castiglione Olona (VA) - Italy
Tel.: +39 0331 866688
Fax: +39 0331 864870

www.fluimac.com
info@fluimac.com